

FP-9-300

Highlights

- Conduction cooled
- Polypropylene dielectric
- Self-healing
- Operating frequency up to 700 KHz
- Maximum operating core temperature 85°C
- Capacitance tolerance $\pm 10\%$
- Flame retardant UL94 - V0, ROHS compliant

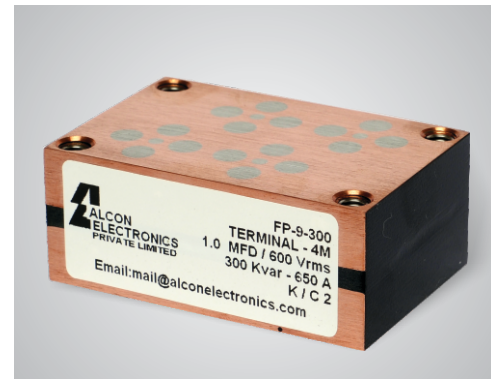

Standard Capacitor Values

Rated Voltage Vrms	Nominal Capacitance MFD at 1KHz	Max Current Irms	Max Power Kvar	Frequency KHz	ESR mΩ	Dimensions mm			Case Code	Terminal Style	Ordering Code
						B	H	L			
1000	0.10	350	300	476-649	1.2	30.2	50	75	F1	4M	SP00U101000A10F1004MK01
	0.20	400	300	238-423	1.2	30.2	50	75	F1	4M	SP00U201000A10F1004MK01
700	0.33	500	300	295-401	1.0	30.2	50	75	F1	4M	SP00U330700A10F1004MK01
	0.66	500	300	147-200	0.8	30.2	50	75	F1	4M	SP00U660700A10F1004MK01
600	1.00	650	300	132-223	0.5	30.2	50	75	F1	4M	SP000010600A10F1004MK01
	1.32	650	300	100-170	0.3	30.2	50	75	F1	4M	SP01U320600A10F1004MK01
500	2.60	650	300	72-85	0.2	30.2	50	75	F1	4M	SP02U600500A10F1004MK01
400	5.00	800	300	59-67	0.1	30.2	50	75	F1	4M	SP000050400A10F1004MK01

Capacitor Drawing and Terminal Style

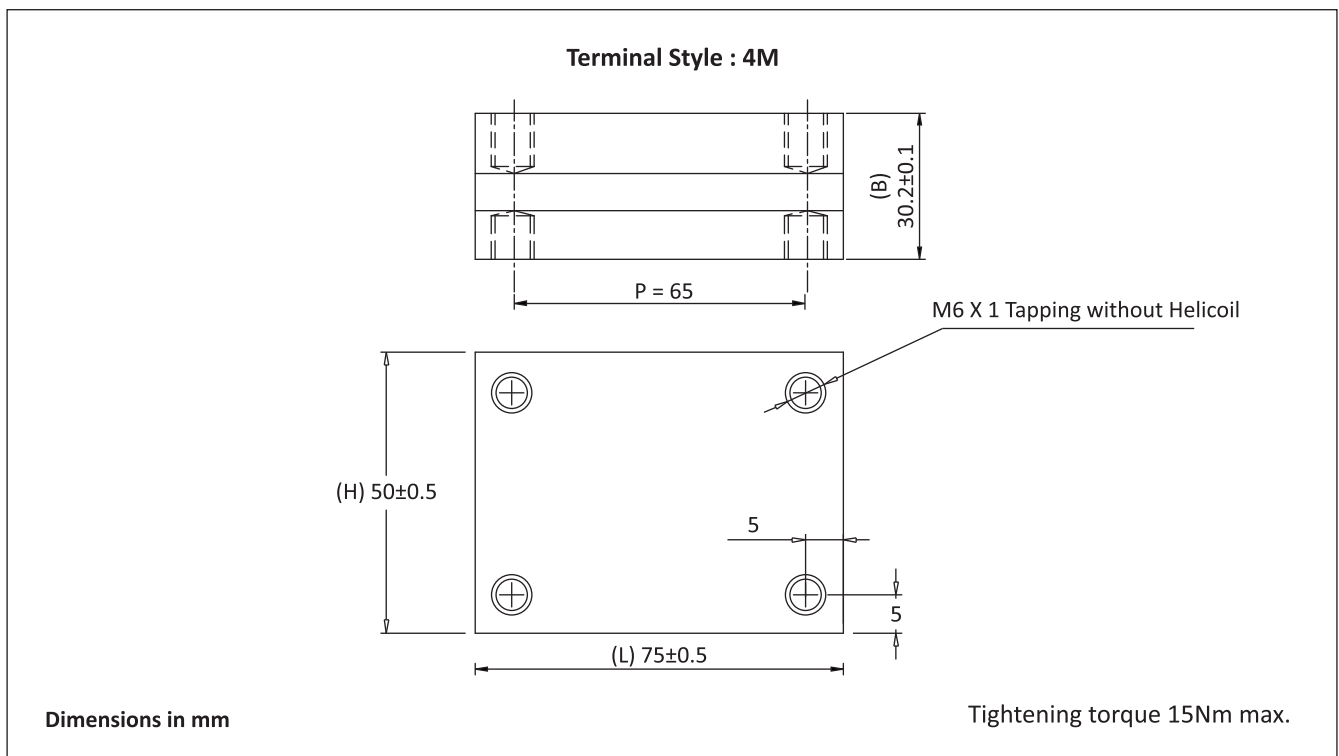

FP-9-300

Frequency Derating

—◆— Voltage —■— Current —▲— Power

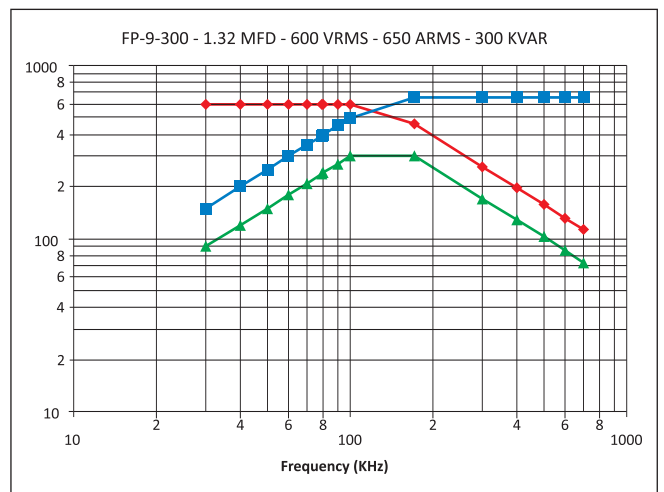
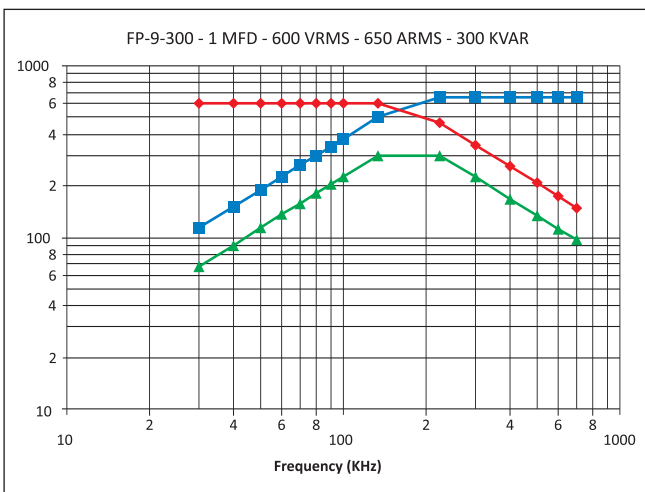
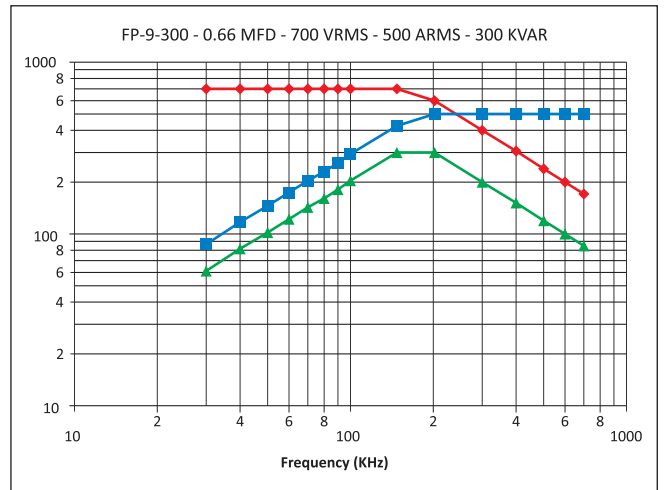
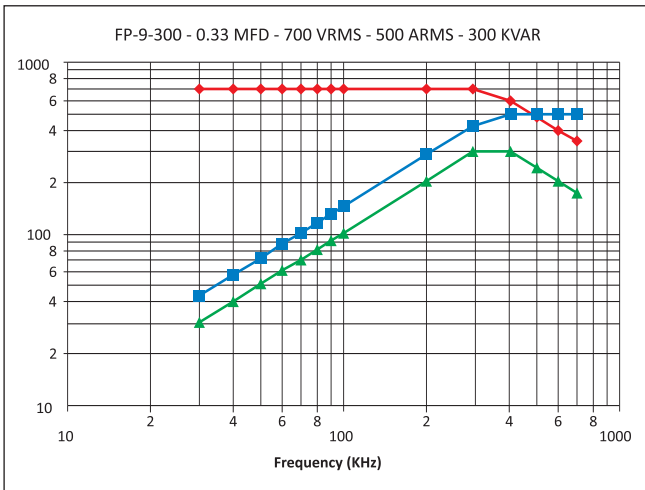
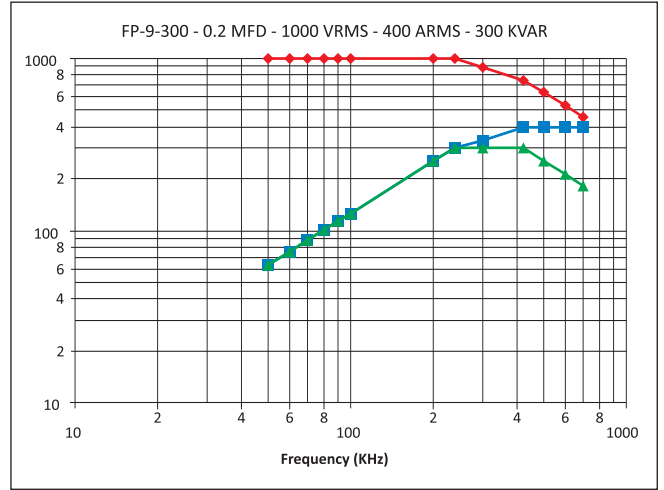
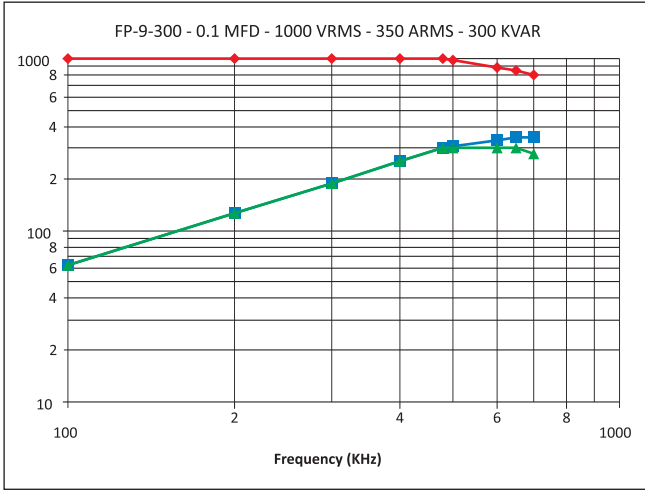

FP-9-300

Frequency Derating

—●— Voltage —■— Current —▲— Power

