

FP-5-200-SM/SP

Highlights

- Conduction cooled
- Polypropylene dielectric
- Self-healing
- Operating frequency up to 1000 KHz
- Maximum operating core temperature 85°C
- Capacitance tolerance $\pm 10\%$
- Flame retardant UL94 - V0, ROHS compliant

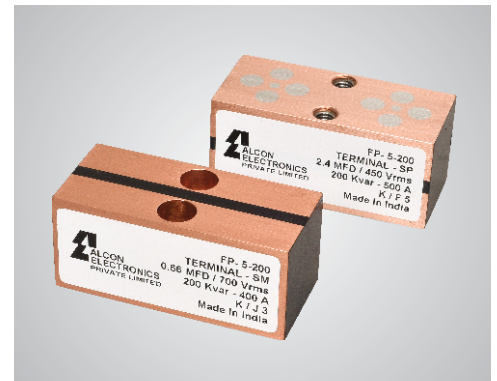

Standard Capacitor Values

Rated Voltage Vrms	Nominal Capacitance MFD at 1KHz	Max Current Irms	Max Power Kvar	Frequency KHz	ESR mΩ	Dimensions mm			Case Code	Terminal Style	Ordering Code
						B	H	L			
1000	0.05	250	200	636-994	1.5	30.2	30	68	D1	SM/SP	SP00U051000AV0D1___K01
	0.10	250	200	318-498	1.2	30.2	30	68	D1	SM/SP	SP00U101000AV0D1___K01
900	0.17	300	200	232-422	1.0	30.2	30	68	D1	SM/SP	SP00U170900AV0D1___K01
800	0.25	300	200	199-286	0.9	30.2	30	68	D1	SM/SP	SP00U250800AV0D1___K01
	0.33	300	200	150-216	0.8	30.2	30	68	D1	SM/SP	SP00U330800AV0D1___K01
	0.50	350	200	98-194	0.6	30.2	30	68	D1	SM/SP	SP00U500800AV0D1___K01
700	0.66	400	200	98-193	0.4	30.2	30	68	D1	SM/SP	SP00U660700AV0D1___K01
600	1.20	450	200	74-134	0.4	30.2	30	68	D1	SM/SP	SP01U200600AV0D1___K01
	1.33	450	200	65-120	0.4	30.2	30	68	D1	SM/SP	SP01U330600AV0D1___K01
450	2.40	500	200	65-85	0.3	30.2	30	68	D1	SM/SP	SP02U400450AV0D1___K01

Capacitor Drawing and Terminal Style

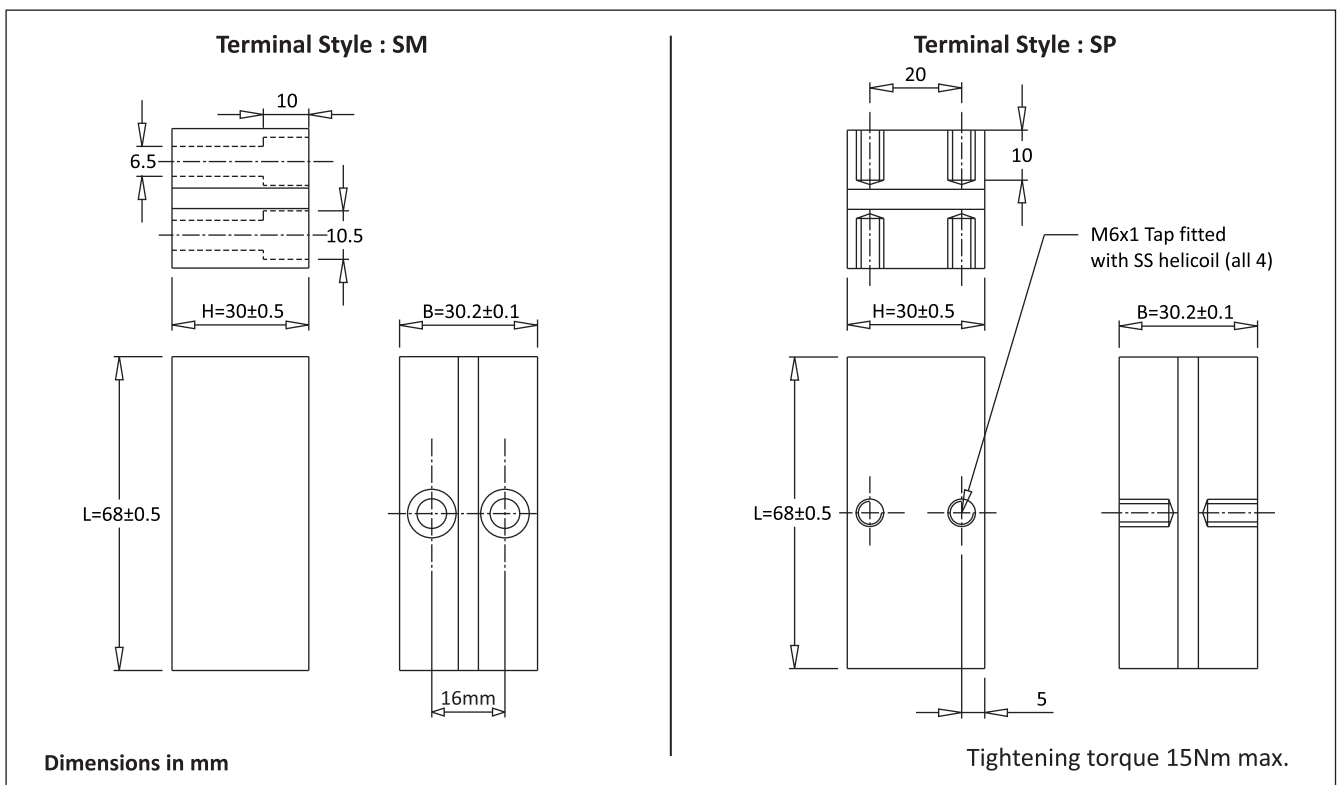

FP-5-200-SM/SP

Frequency Derating

—◆— Voltage —■— Current —▲— Power

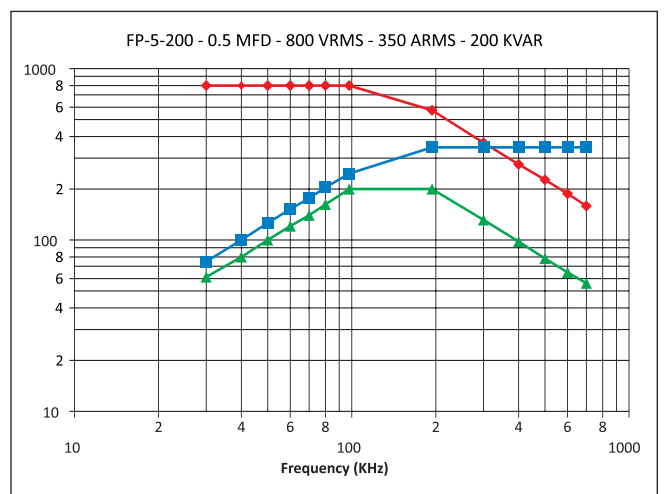
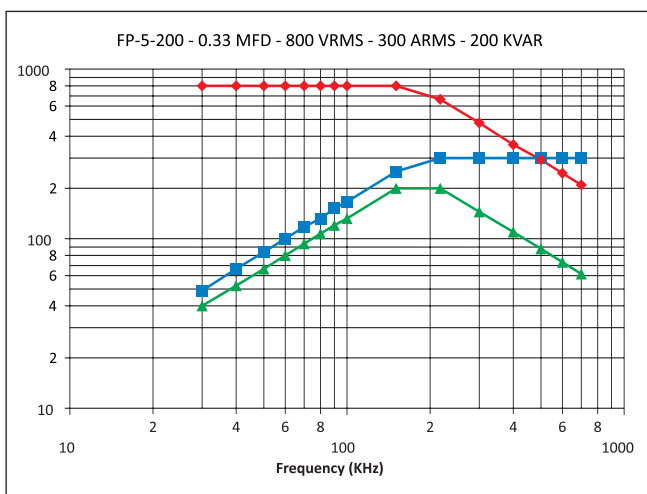
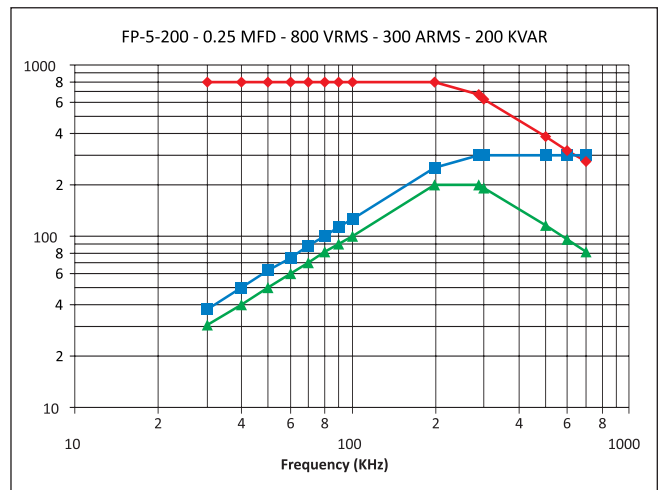
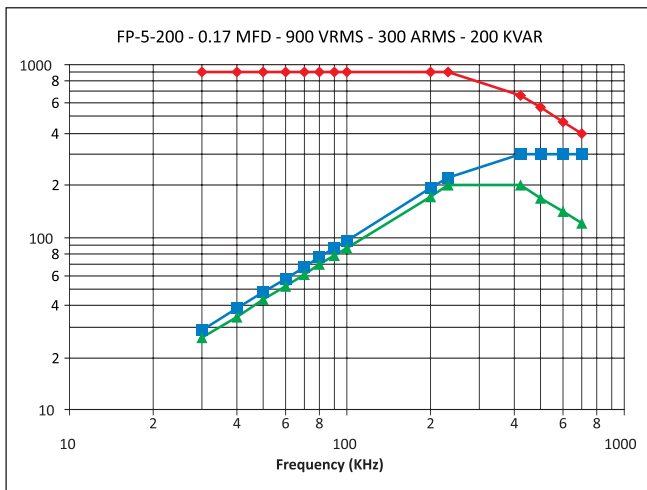
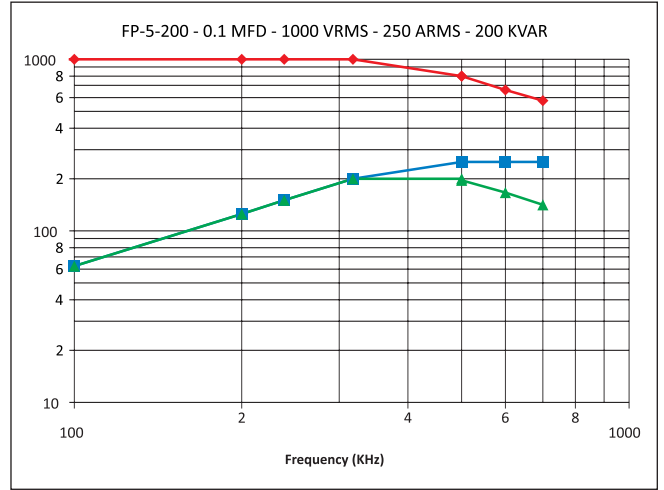
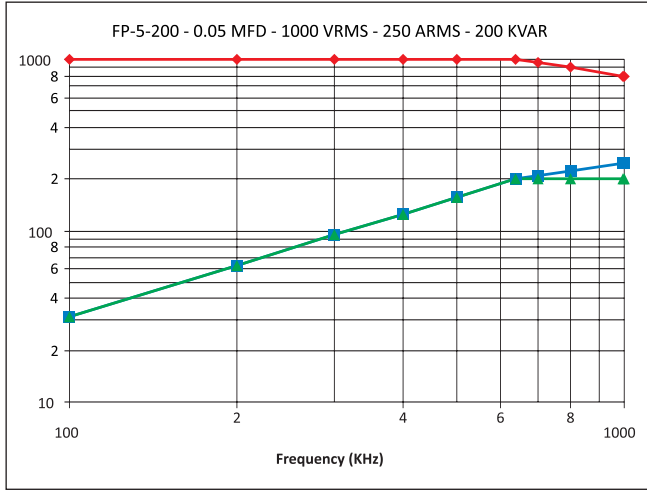

FP-5-200-SM/SP

Frequency Derating

—◆— Voltage —■— Current —▲— Power

