

FP-38-300-SM

Highlights

- Conduction cooled
- Polypropylene dielectric
- Self-healing
- Operating frequency up to 1000 KHz
- Maximum operating core temperature 85°C
- Capacitance tolerance $\pm 10\%$
- Flame retardant UL94 - V0, ROHS compliant

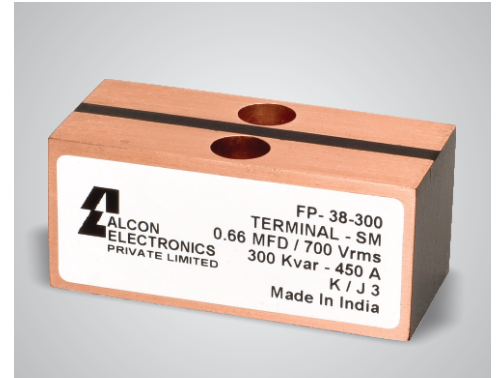

Standard Capacitor Values

Rated Voltage Vrms	Nominal Capacitance MFD at 1KHz	Max Current Irms	Max Power Kvar	Frequency KHz	ESR mΩ	Dimensions mm			Case Code	Terminal Style	Ordering Code
						B	H	L			
1000	0.10	300	300	478	1.5	30.2	30	68	D1	SM	SP00U101000AX0D100SMK01
	0.17	300	300	281	1.4	30.2	30	68	D1	SM	SP00U171000AX0D100SMK01
800	0.33	400	300	225-256	1.2	30.2	30	68	D1	SM	SP00U330800AX0D100SMK01
	0.50	400	300	149-170	1.1	30.2	30	68	D1	SM	SP00U500800AX0D100SMK01
700	0.66	450	300	147-163	1.0	30.2	30	68	D1	SM	SP00U660700AX0D100SMK01
600	1.33	500	300	99	0.9	30.2	30	68	D1	SM	SP01U330600AX0D100SMK01
500	2.40	600	300	79	0.8	30.2	30	68	D1	SM	SP02U400500AX0D100SMK01

Capacitor Drawing and Terminal Style

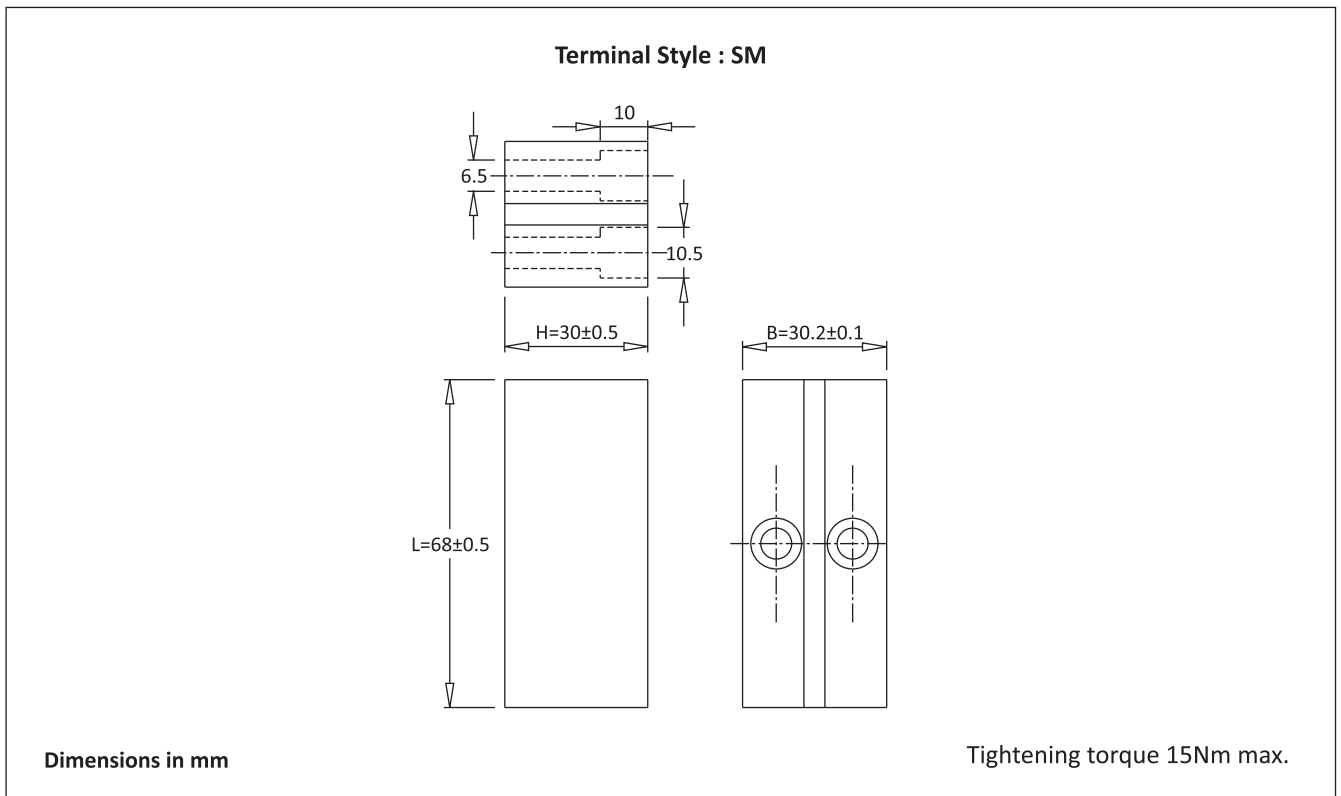

FP-38-300-SM

Frequency Derating

—◆— Voltage —■— Current —▲— Power

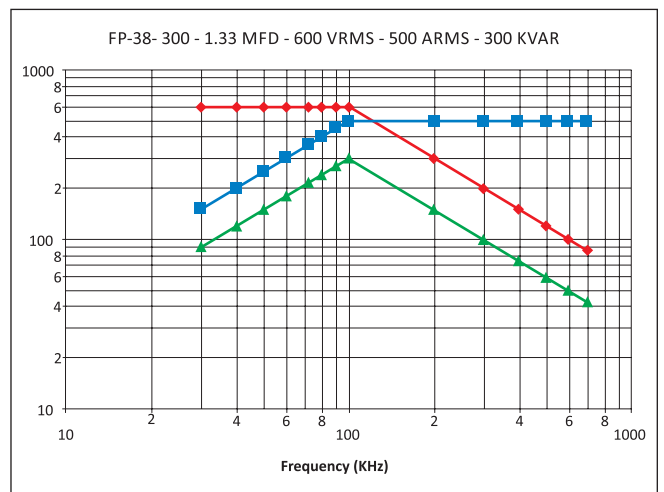
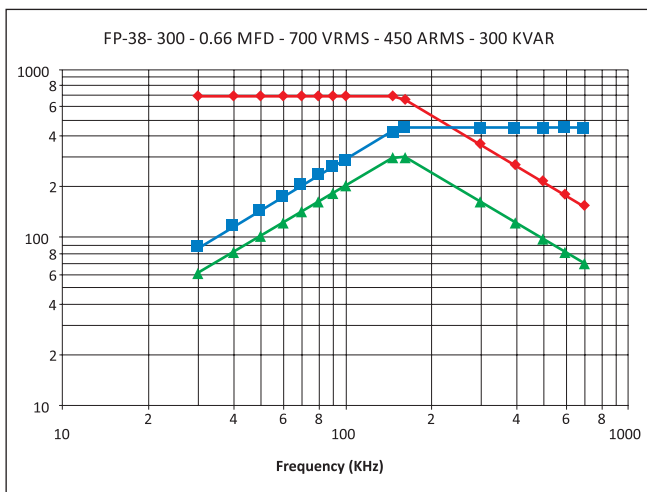
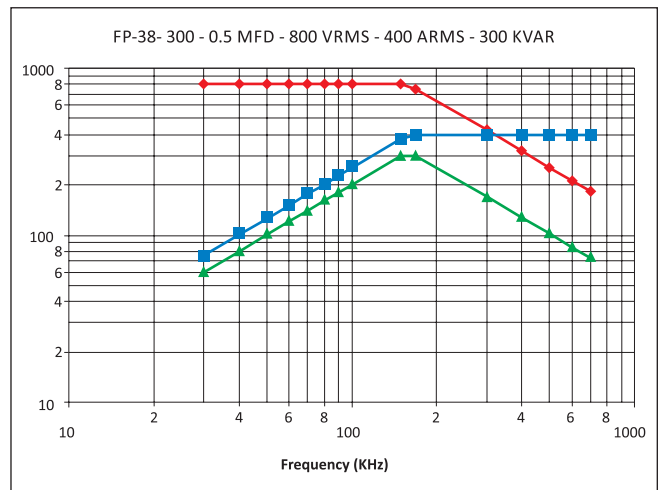
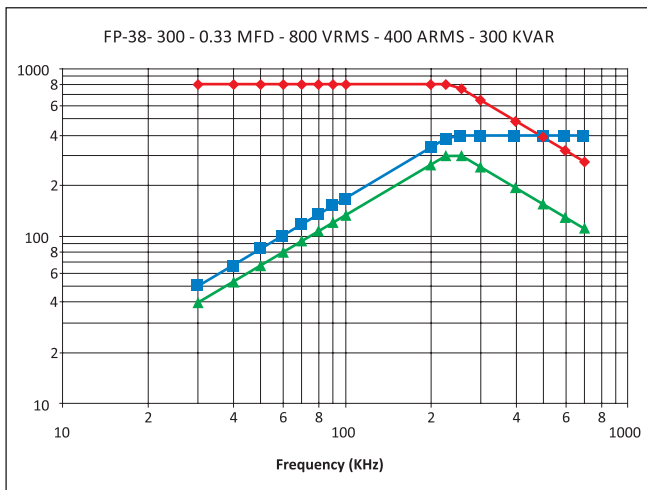
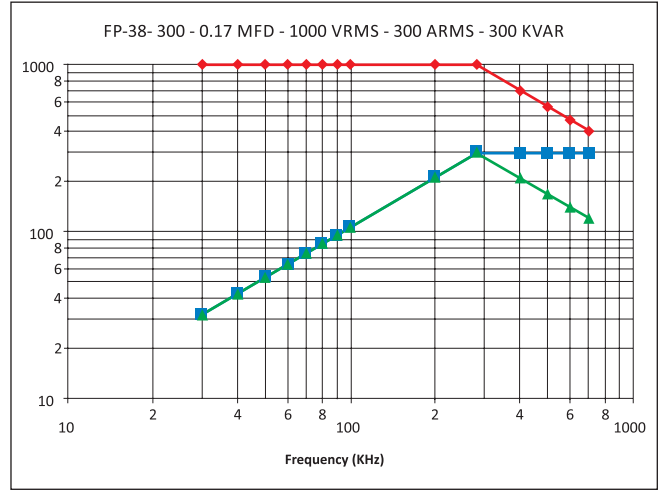
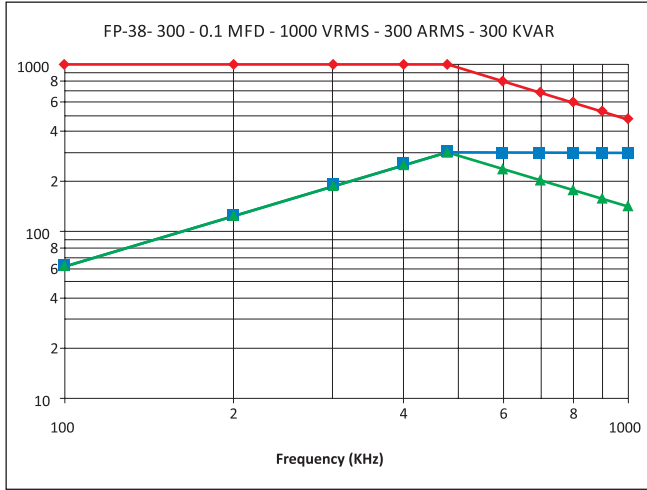

FP-38-300-SM

Frequency Derating

