

FP-12-500H

Highlights

- Water cooled
- Polypropylene dielectric
- Self-healing
- Operating frequency 100KHz
- Maximum operating core temperature 85°C
- Capacitance tolerance ±10%
- Flame retardant UL94 - V0, ROHS compliant



Standard Capacitor Values

Rated Voltage Vrms	Nominal capacitance MFD at 1KHz	Max current Irms	Max power Kvars	Frequency KHz	ESR mΩ	Dimensions mm			Case Code	Terminal Style	Ordering Code
						∅D	H	∅d			
1100	1.2	600	500	55-96	1.5	80	71.5	60	W1	STD	SP01U201100BK0W10STDK01
	1.4	600	500	46-83	1.2	80	71.5	60	W1	STD	SP01U401100BK0W10STDK01
750	3.0	800	500	47-68	1.1	80	71.5	60	W1	STD	SP000030750BK0W10STDK01
	3.3	800	500	43-62	1.0	80	71.5	60	W1	STD	SP003U30750BK0W10STDK01
900	4.0	700	500	25-39	0.9	102	71.5	60	W4	STD	SP000040900BK0W40STDK01
700	5.6	1000	500	29-57	0.9	80	71.5	60	W1	STD	SP005U60700BK0W10STDK01
	6.3	1000	500	26-51	0.8	80	71.5	60	W1	STD	SP006U30700BK0W10STDK01
	8.5	1000	500	19-38	0.7	88	71.5	60	W2	STD	SP008U50700BK0W20STDK01
500	10	1000	500	16-32	0.6	95	71.5	60	W3	STD	SP000100700BK0W30STDK01
	21	1000	500	15	0.4	80	71.5	60	W1	STD	SP000210500BK0W10STDK01
550	27	1000	500	10-12	0.3	102	71.5	60	W4	STD	SP000270550BK0W40STDK01
500	33	1000	500	10	0.3	102	71.5	60	W4	STD	SP000330500BK0W40STDK01
	37	1000	500	9	0.2	102	71.5	60	W4	STD	SP000370500BK0W40STDK01

Capacitor Drawing and Terminal Style

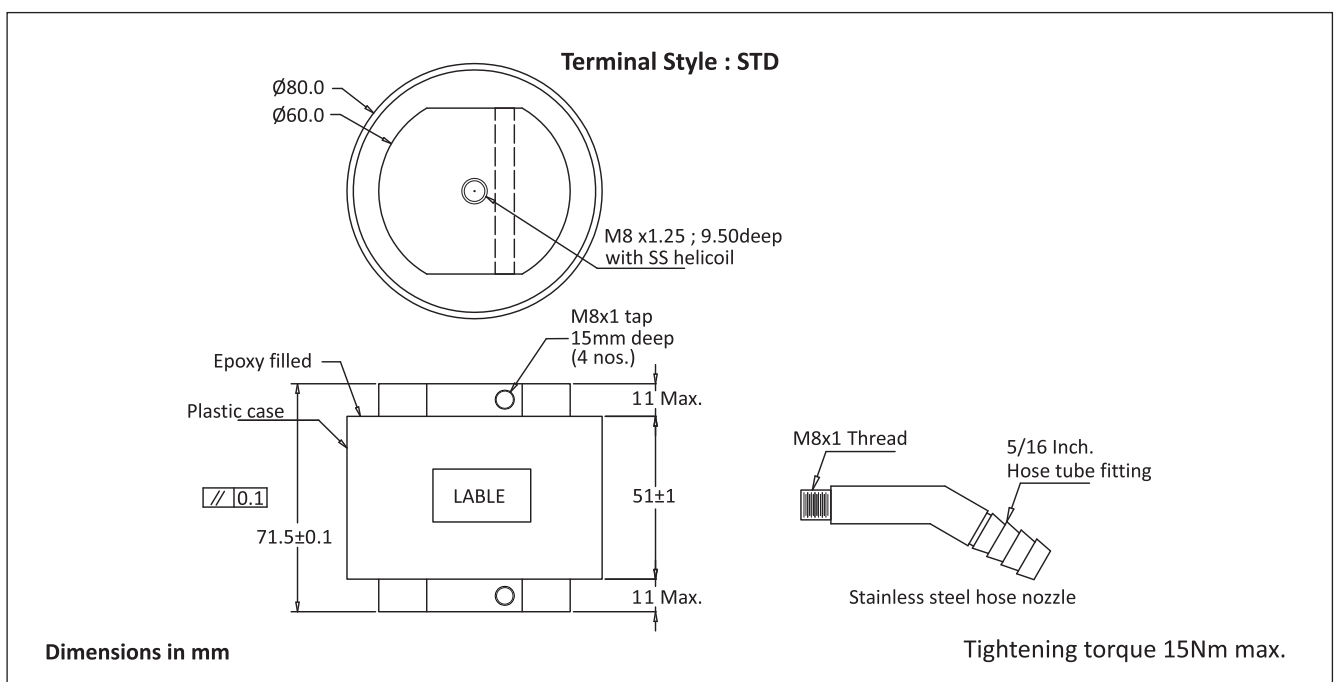

FP-12-500H

Frequency Derating

—◆— Voltage —■— Current —▲— Power

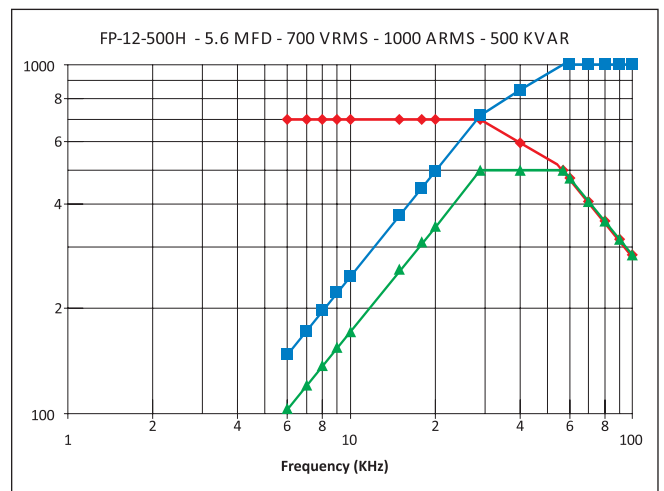
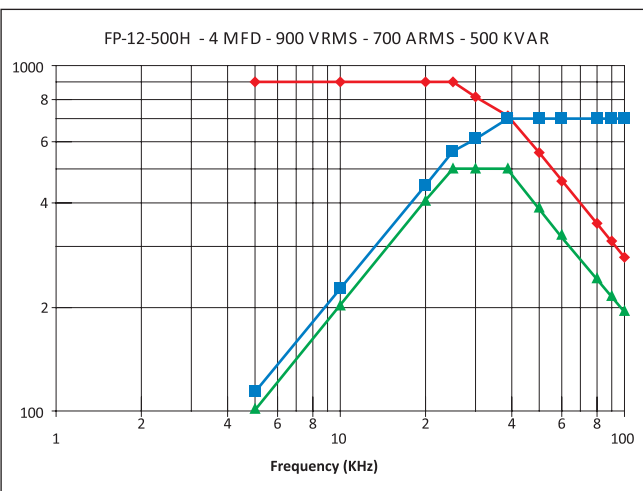
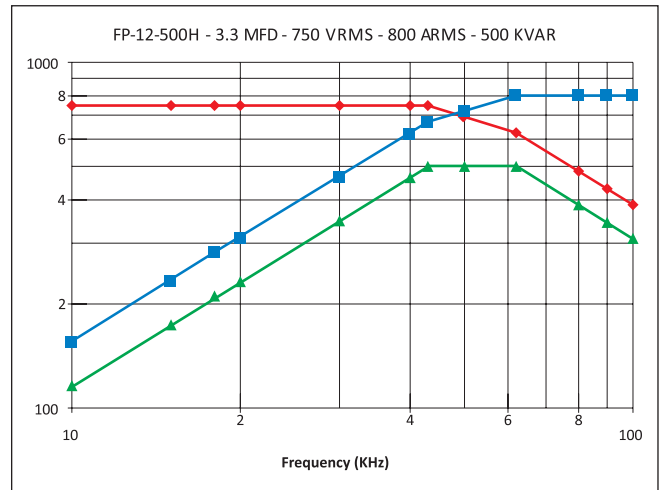
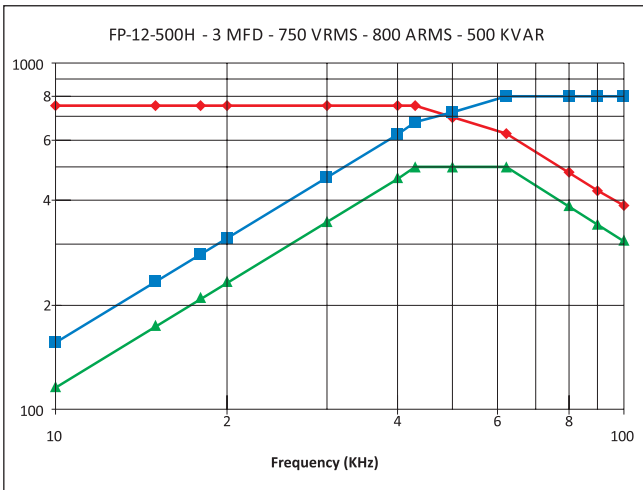
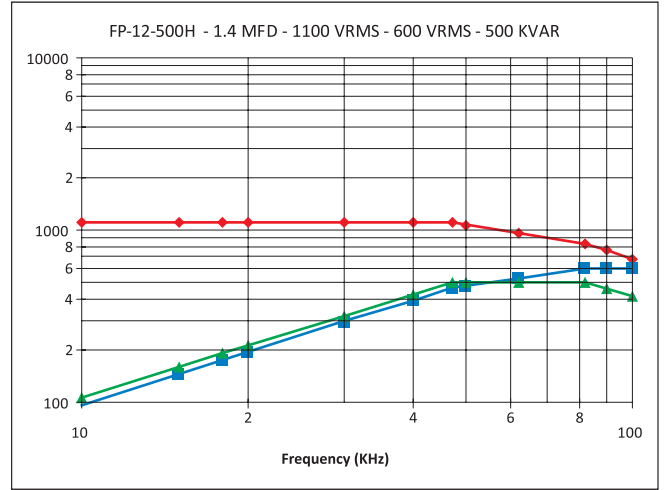
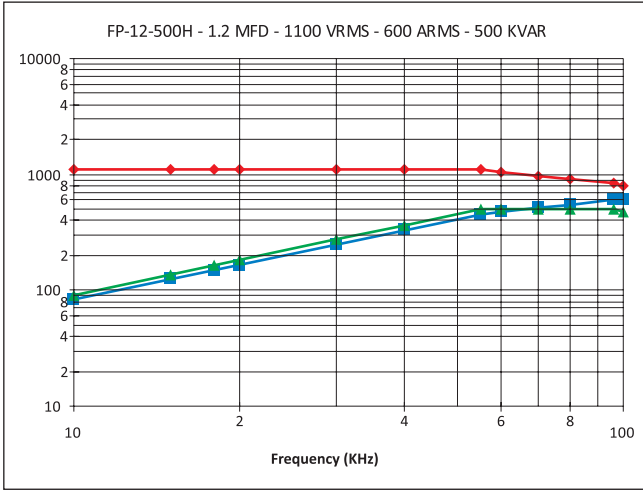

FP-12-500H

Frequency Derating

—●— Voltage —■— Current —▲— Power

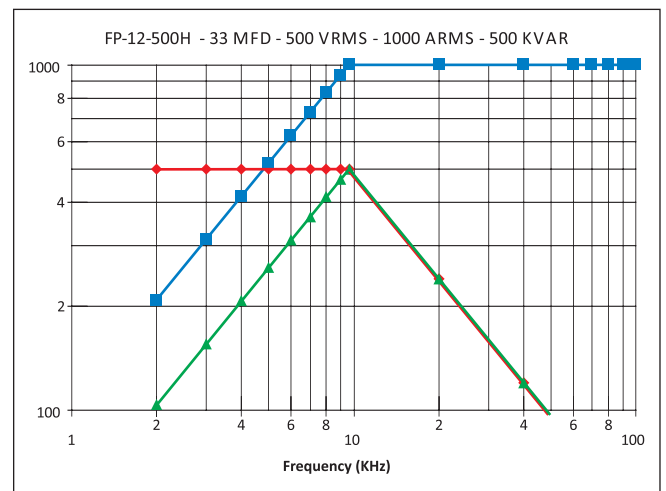
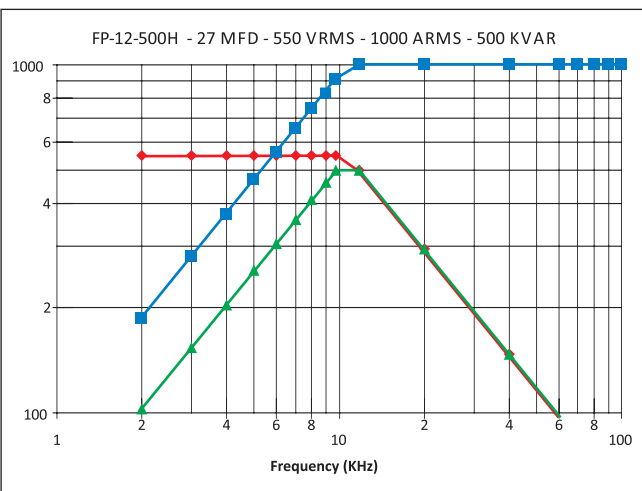
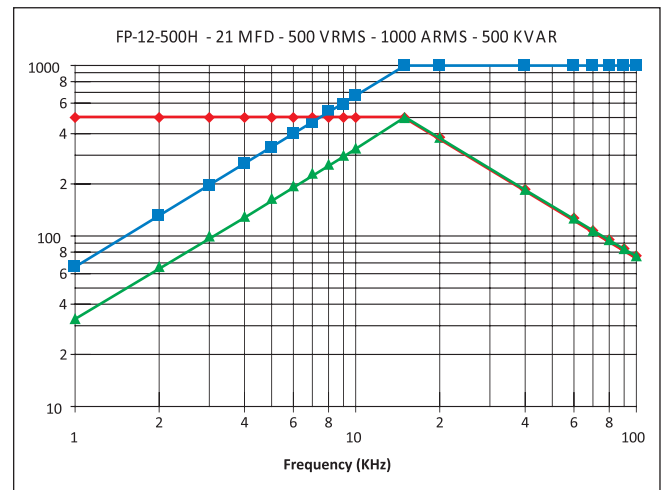
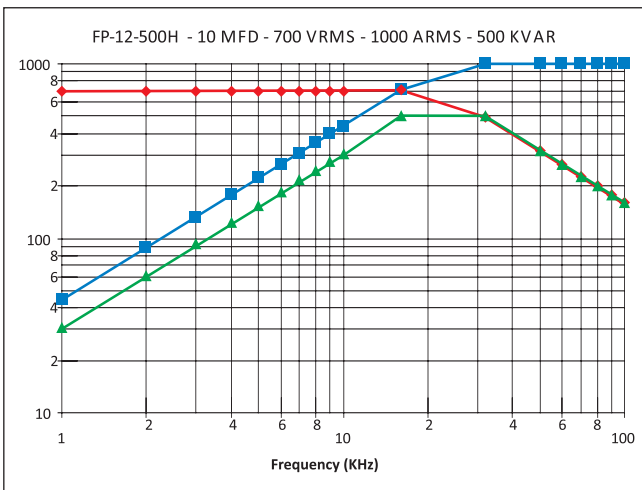
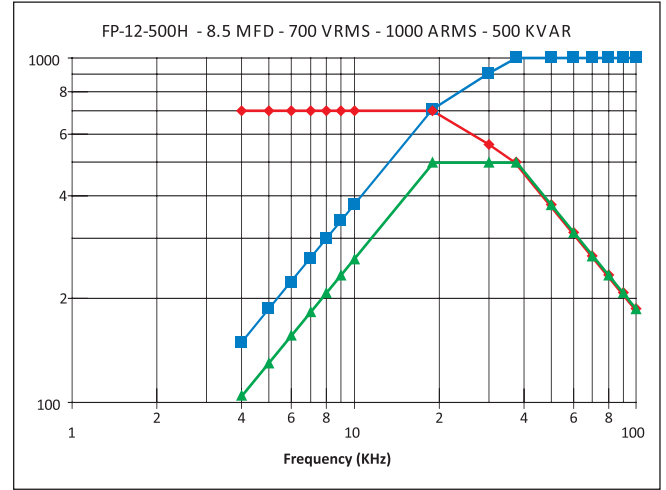
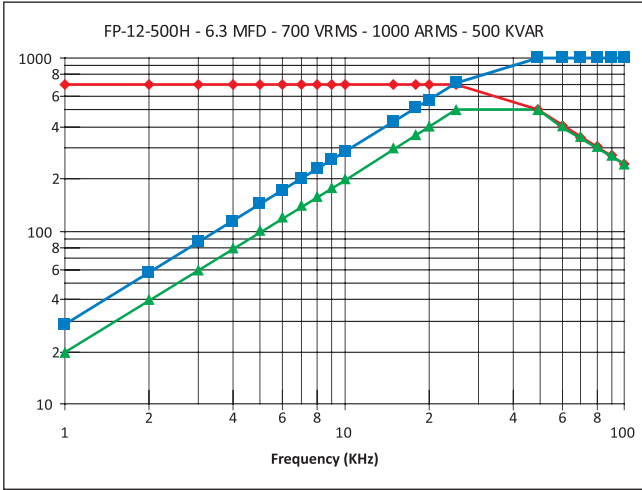

FP-12-500H

Frequency Derating

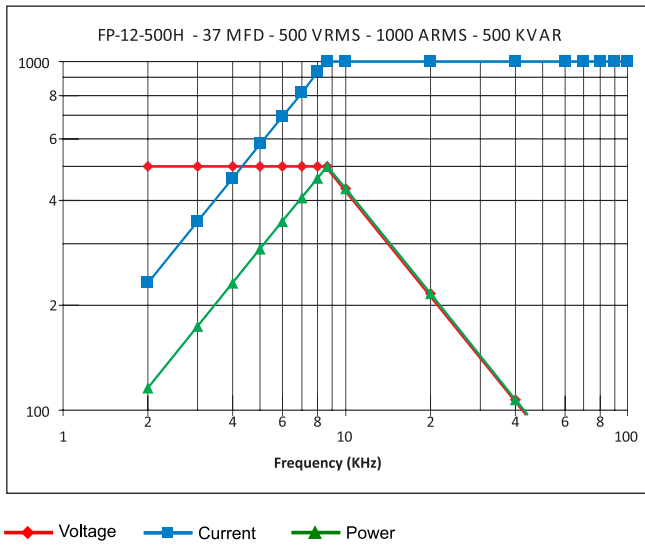

Catalogue No. AEPL FP-12-500H-JULY-2019 (Rev 01)

The specification shown herein (page 1 to 4) pertain to the current manufacturing range of the Company. The Company reserves the right to change and /or modify any part of or whole of the specifications as a result of research and development and as may be necessary, without prior notice

All Products not for marketing / sale in all countries.