

## FP-11-500

### Highlights

- Conduction cooled
- 100% leak proof
- Polypropylene dielectric
- Self-healing
- Operating frequency 100KHz
- Maximum operating core temperature 85°C
- Capacitance tolerance  $\pm 10\%$
- Flame retardant UL94 - V0, ROHS compliant



### Standard Capacitor Values

Rated Voltage Vrms	Nominal capacitance MFD at 1KHz	Max current Irms	Max power Kvars	Frequency KHz	ESR mΩ	Dimensions mm			Case Code	Terminal Style	Ordering Code
						ØD	H	Ød			
1100	1.2	600	500	55-96	1.5	80	71.5	60	W1	STD	SP01U201100A90W10STDK01
	1.4	600	500	46-83	1.2	80	71.5	60	W1	STD	SP01U401100A90W10STDK01
750	3.0	800	500	47-68	1.1	80	71.5	60	W1	STD	SP000030750A90W10STDK01
	3.3	800	500	43-62	1.0	80	71.5	60	W1	STD	SP03U300750A90W10STDK01
900	4.0	700	500	25-39	0.9	102	71.5	60	W4	STD	SP000040900A90W40STDK01
700	5.6	1000	500	29-57	0.9	80	71.5	60	W1	STD	SP05U600700A90W10STDK01
	6.3	1000	500	26-51	0.8	80	71.5	60	W1	STD	SP06U300700A90W10STDK01
	8.5	1000	500	19-38	0.7	88	71.5	60	W2	STD	SP08U500700A90W20STDK01
	10	1000	500	16-32	0.6	95	71.5	60	W3	STD	SP000100700A90W30STDK01
500	21	1000	500	15	0.4	80	71.5	60	W1	STD	SP000210500A90W10STDK01
550	27	1000	500	10-12	0.3	102	71.5	60	W4	STD	SP000270550A90W40STDK01
500	33	1000	500	10	0.3	102	71.5	60	W4	STD	SP000330500A90W40STDK01
	37	1000	500	9	0.2	102	71.5	60	W4	STD	SP000370500A90W40STDK01

### Capacitor Drawing and Terminal Style

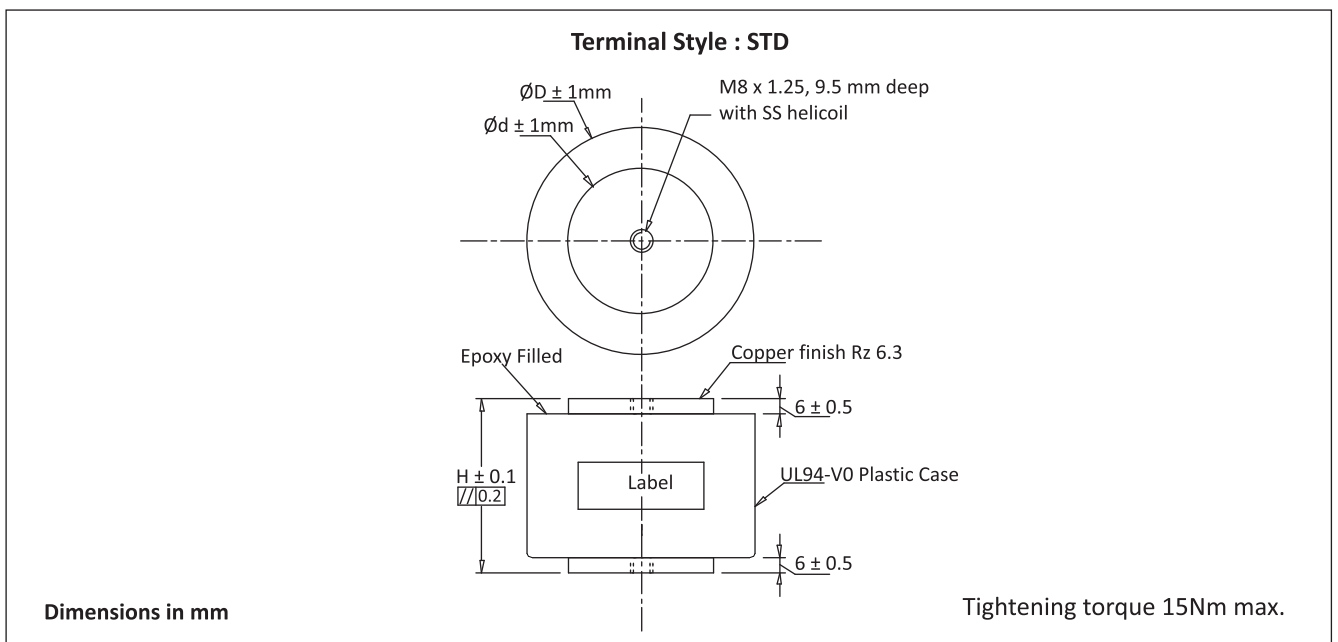

## FP-11-500

### Frequency Derating

—◆— Voltage    —■— Current    —▲— Power

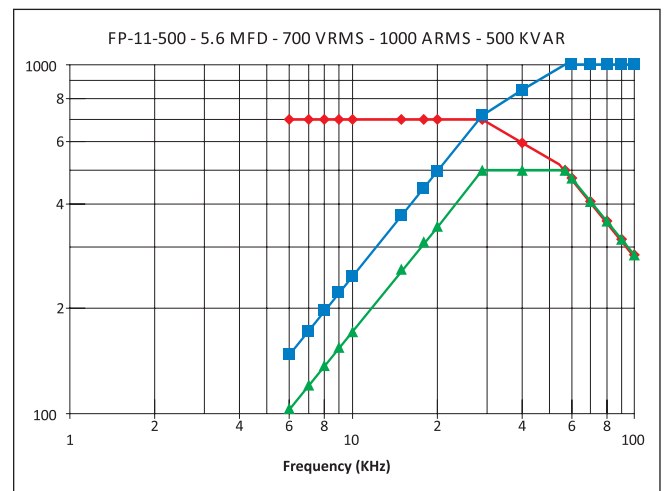
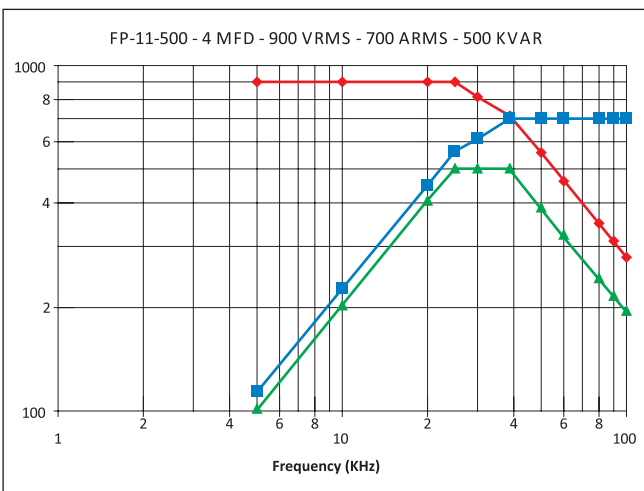
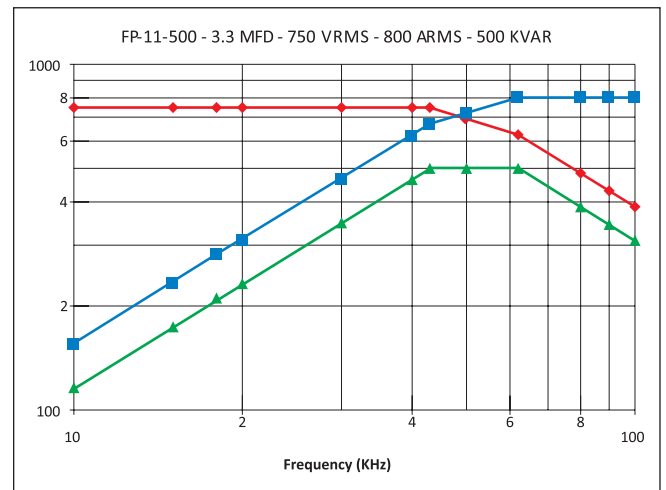
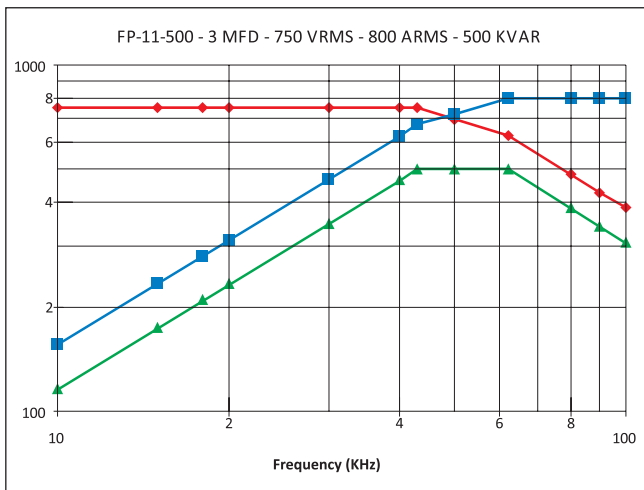
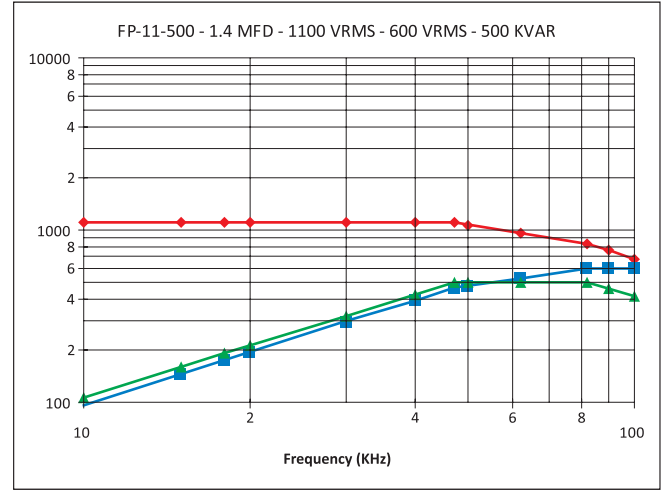
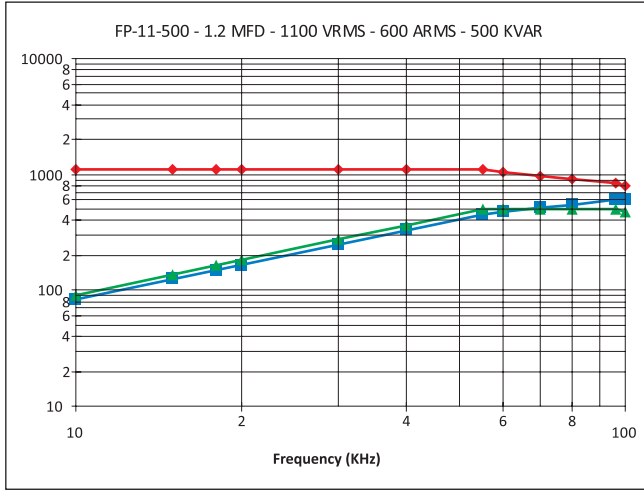

## FP-11-500

### Frequency Derating

—●— Voltage    —■— Current    —▲— Power

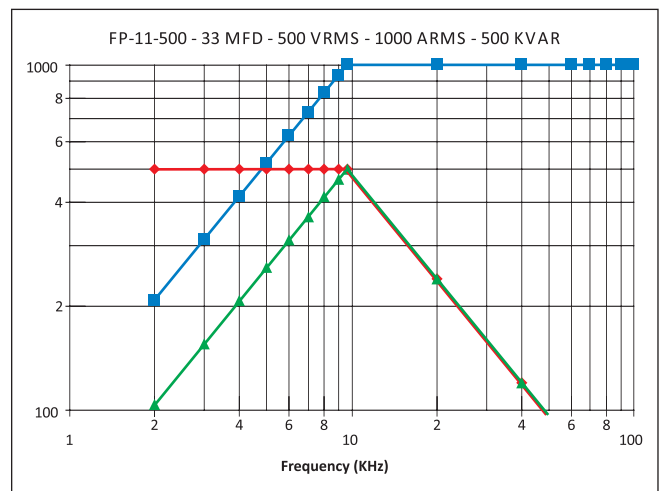
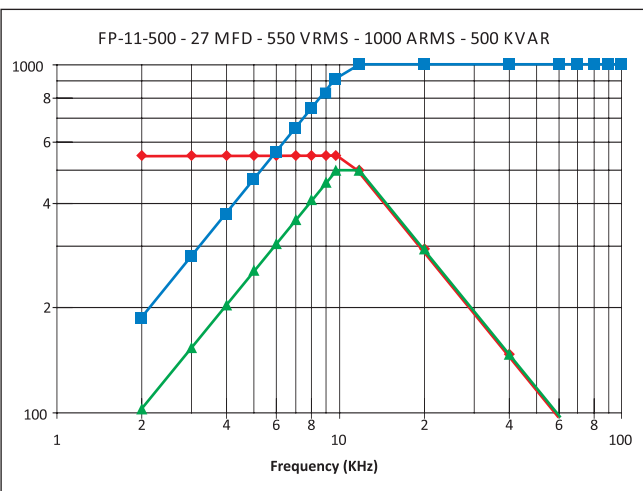
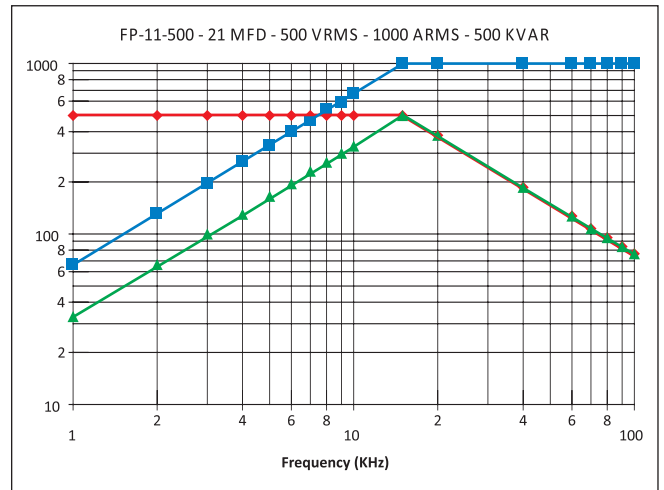
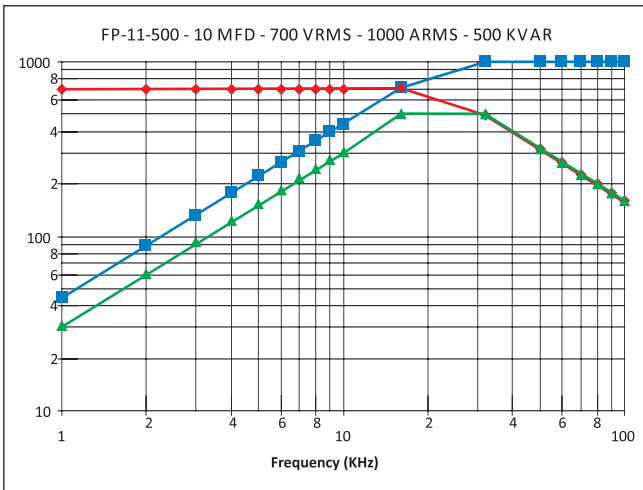
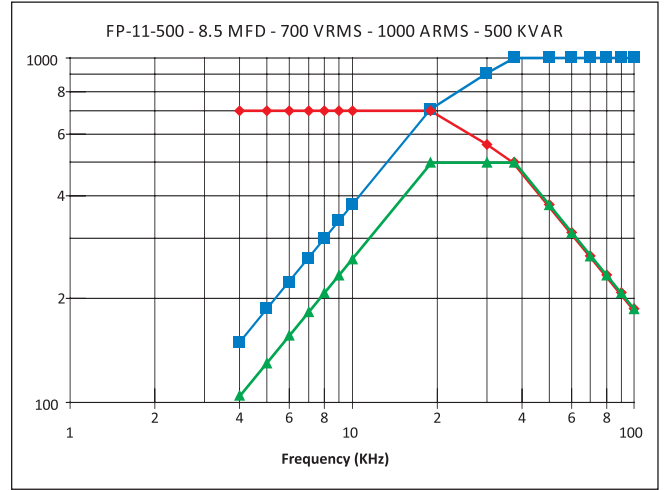
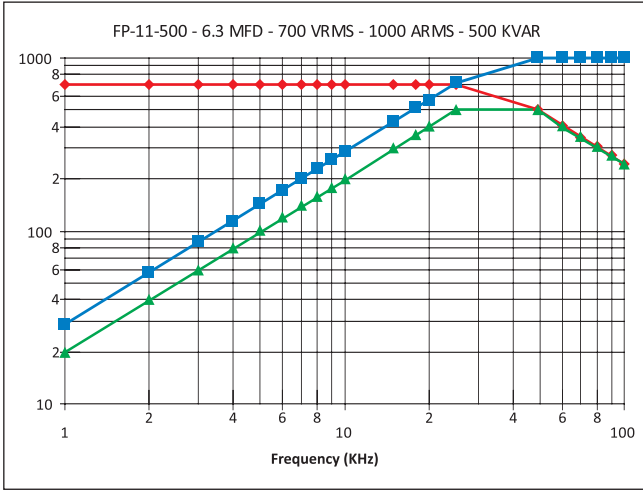

## FP-11-500

### Frequency Derating

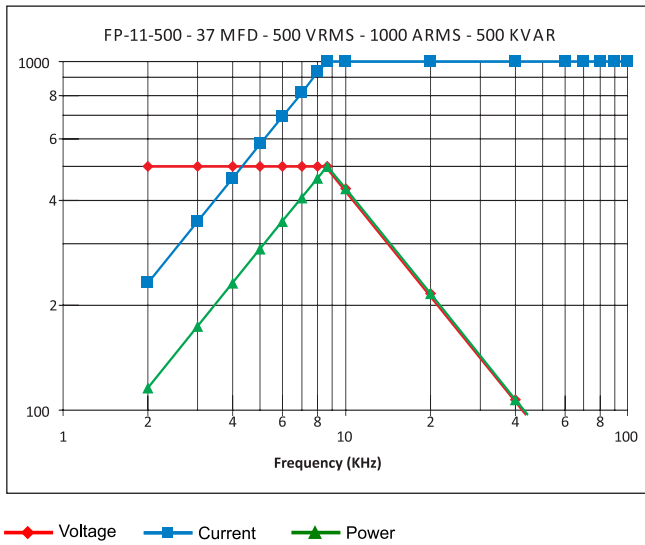

Catalogue No. AEPL FP-11-500-JULY-2019 (Rev 01)

The specification shown herein ( page 1 to 4 ) pertain to the current manufacturing range of the Company. The Company reserves the right to change and /or modify any part of or whole of the specifications as a result of research and development and as may be necessary, without prior notice

All Products not for marketing / sale in all countries.