

FP-4-150-SM/SP

Highlights

- Conduction cooled
- Polypropylene dielectric
- Self-healing
- Operating frequency up to 700 KHz
- Maximum operating core temperature 85°C
- Capacitance tolerance $\pm 10\%$
- Flame retardant UL94 - V0, ROHS compliant

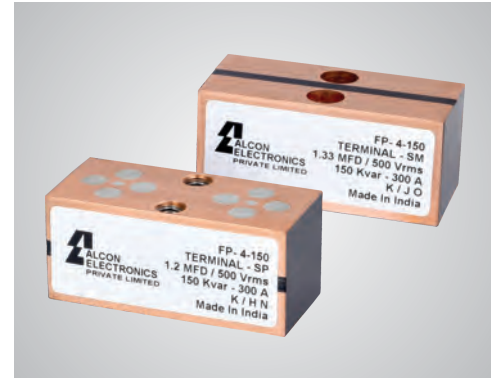

Standard Capacitor Values

Rated Voltage Vrms	Nominal Capacitance MFD at 1KHz	Max Current Irms	Max Power Kvar	Frequency KHz	ESR mΩ	Dimensions mm			Case Code	Terminal Style	Ordering Code
						B	H	L			
1000	0.05	200	150	478-700	1.5	30.2	30	68	D1	SM/SP	SP00U051000AS0D1___K01
	0.10	200	150	238-423	1.5	30.2	30	68	D1	SM/SP	SP00U101000AS0D1___K01
700	0.17	250	150	286-389	1.2	30.2	30	68	D1	SM/SP	SP00U170700AS0D1___K01
	0.25	250	150	195-265	1.2	30.2	30	68	D1	SM/SP	SP00U250700AS0D1___K01
	0.33	250	150	148-200	1.0	30.2	30	68	D1	SM/SP	SP00U330700AS0D1___K01
	0.50	250	150	93-132	1.0	30.2	30	68	D1	SM/SP	SP00U500700AS0D1___K01
600	0.66	300	150	100-145	0.8	30.2	30	68	D1	SM/SP	SP00U660600AS0D1___K01
500	1.20	300	150	79-80	0.6	30.2	30	68	D1	SM/SP	SP01U200500AS0D1___K01
	1.33	300	150	72	0.6	30.2	30	68	D1	SM/SP	SP01U330500AS0D1___K01
400	2.40	400	150	63-72	0.6	30.2	30	68	D1	SM/SP	SP02U400400AS0D1___K01

Capacitor Drawing and Terminal Style

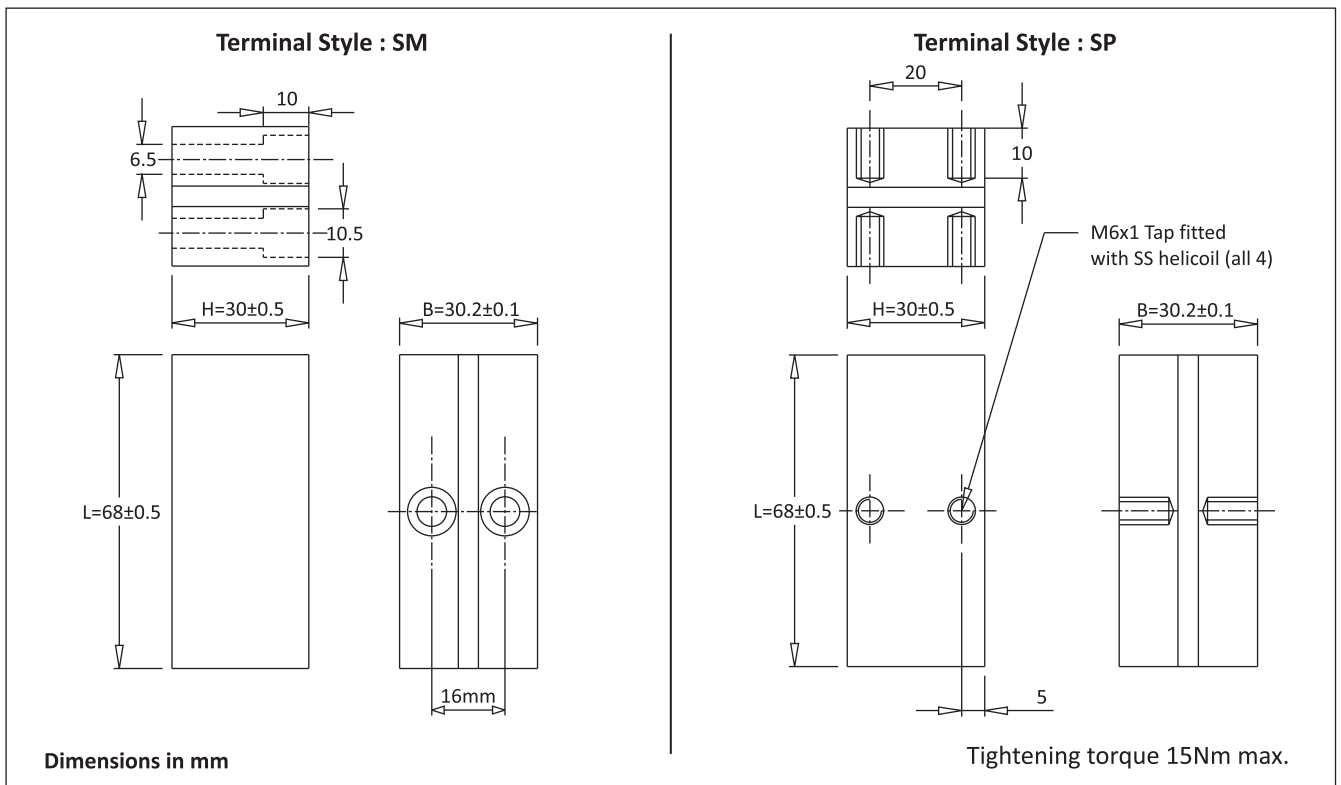

FP-4-150-SM/SP

Frequency Derating

—◆— Voltage —■— Current —▲— Power

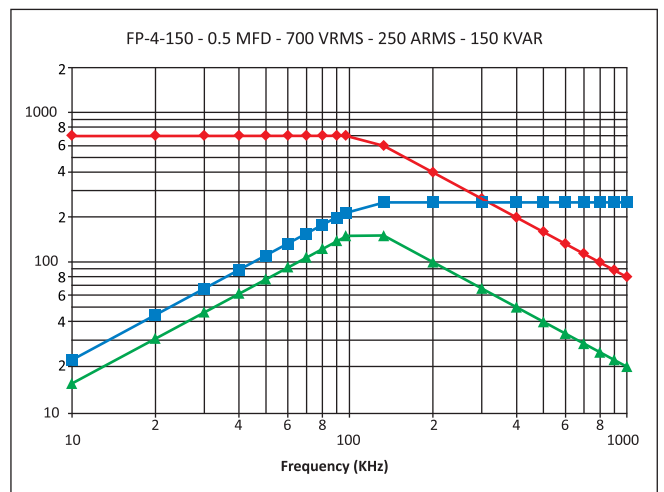
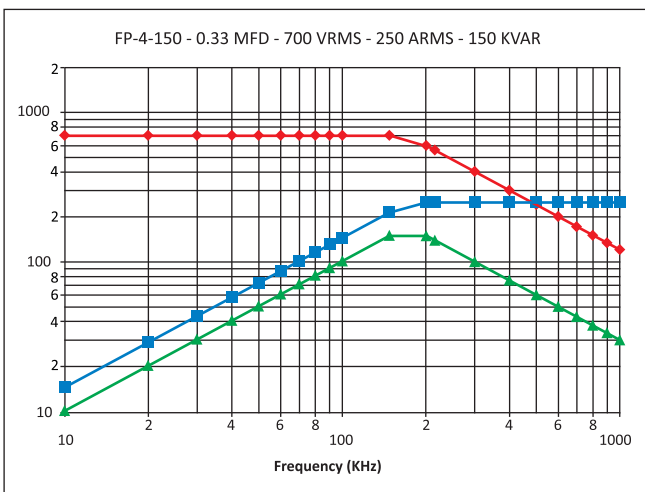
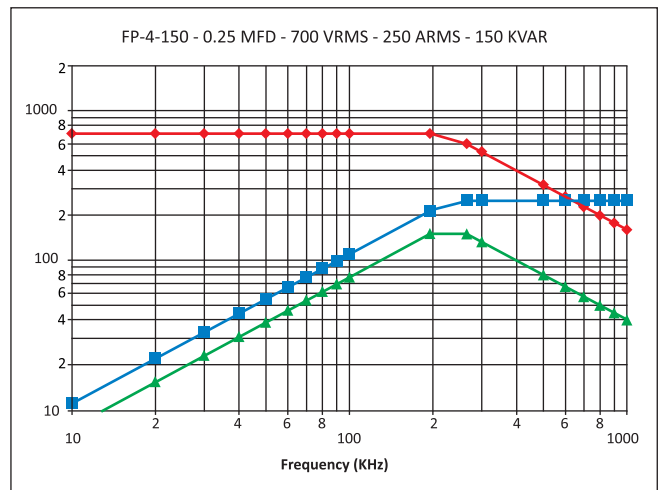
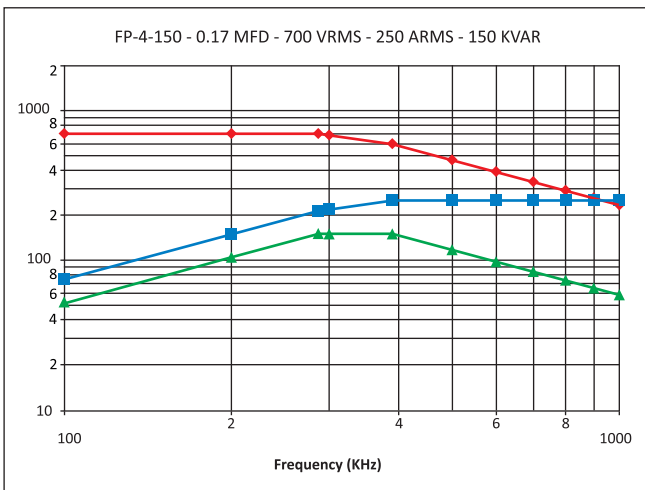
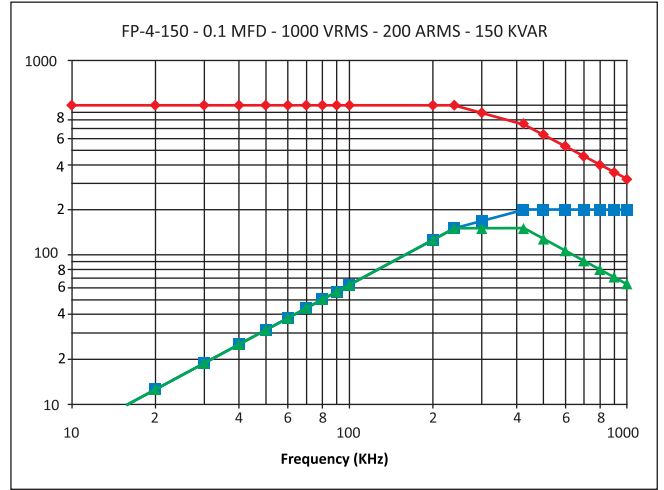
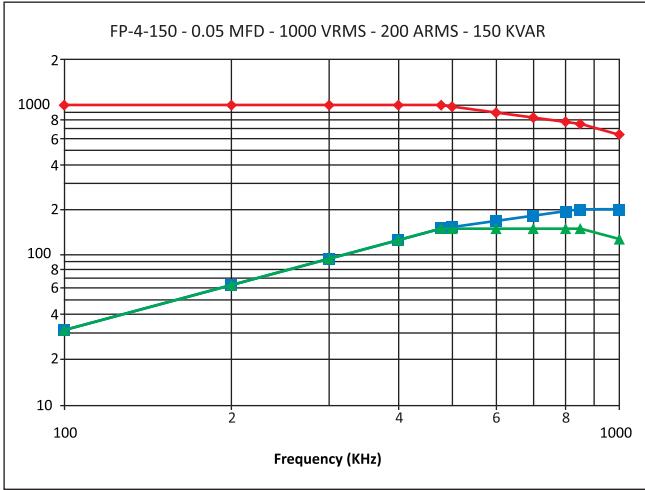

FP-4-150-SM/SP

Frequency Derating

—●— Voltage —■— Current —▲— Power

