

## FP-36-500

### Highlights

- Conduction cooled
- Polypropylene dielectric
- Self-healing
- Operating frequency 100KHz
- Maximum operating core temperature 85°C
- Capacitance tolerance  $\pm 10\%$
- Flame retardant UL94 - V0, ROHS compliant



### Standard Capacitor Values

Rated Voltage Vrms	Nominal capacitance MFD at 1KHz	Max current Irms	Max power Kvars	Frequency KHz	ESR mΩ	Dimensions mm			Case Code	Terminal Style	Ordering Code
						B	H	L			
1100	1.2	600	500	55-96	1.5	100	54	100	G1	5H	SP001U211000BAG1005HK01
	1.4	600	500	46-83	1.2	100	54	100	G1	5H	SP01U401100BA0G1005HK01
750	3.0	800	500	47-68	1.1	100	54	100	G1	5H	SP000030750BA0G1005HK01
	3.3	800	500	43-62	1.0	100	54	100	G1	5H	SP003U30750BA0G1005HK01
900	4.0	700	500	25-39	0.9	100	54	100	G1	5H	SP000040900BA0G1005HK01
700	5.6	1000	500	29-57	0.9	100	54	100	G1	5H	SP005U60700BA0G1005HK01
	6.3	1000	500	26-51	0.8	100	54	100	G1	5H	SP006U30700BA0G1005HK01
	8.5	1000	500	19-38	0.7	100	54	100	G1	5H	SP008U50700BA0G1005HK01
	10	1000	500	16-32	0.6	100	54	100	G1	5H	SP000100700BA0G1005HK01
500	21	1000	500	15	0.4	100	54	100	G1	5H	SP000210500BA0G1005HK01
550	27	1000	500	10-12	0.3	100	54	100	G1	5H	SP000270550BA0G1005HK01
500	33	1000	500	10	0.3	100	54	100	G1	5H	SP000330500BA0G1005HK01
	37	1000	500	9	0.2	100	54	100	G1	5H	SP000370500BA0G1005HK01

### Capacitor Drawing and Terminal Style

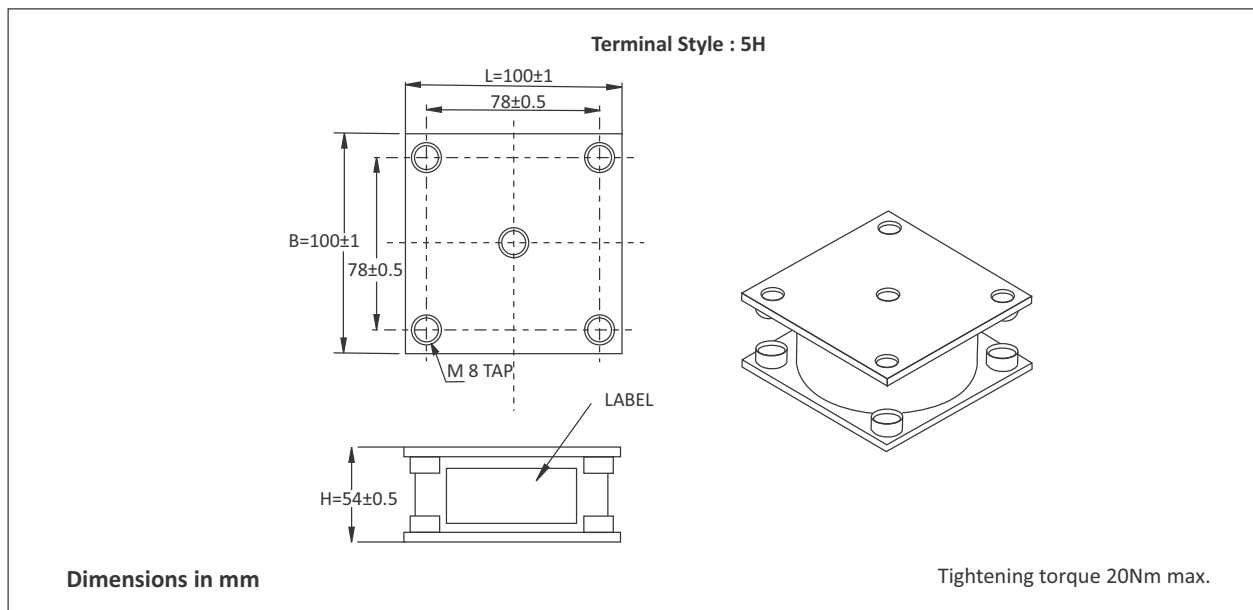

## FP-36-500

### Frequency Derating

—◆— Voltage    —■— Current    —▲— Power

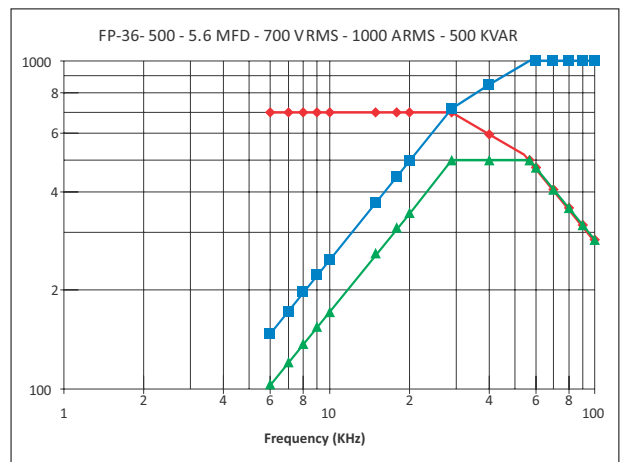
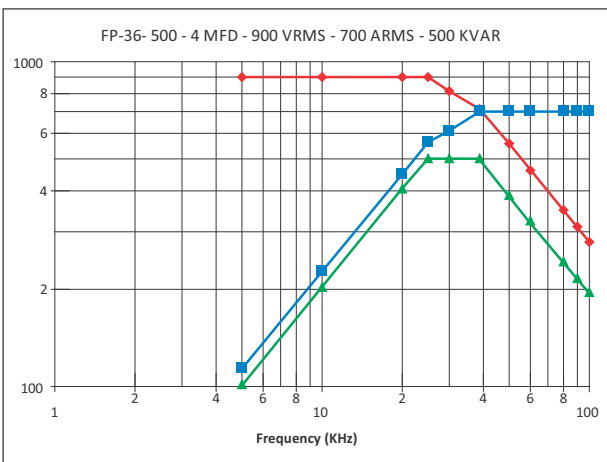
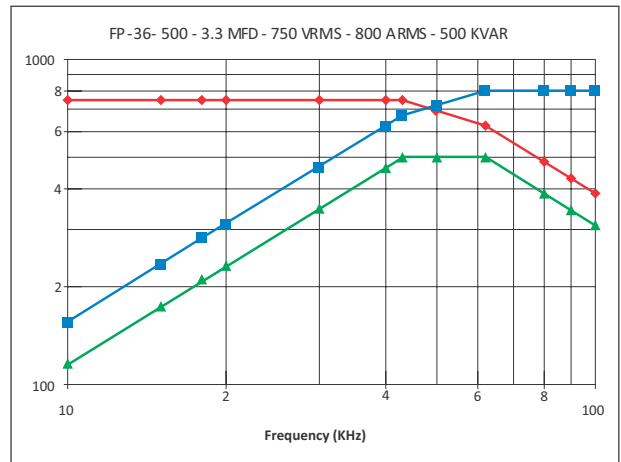
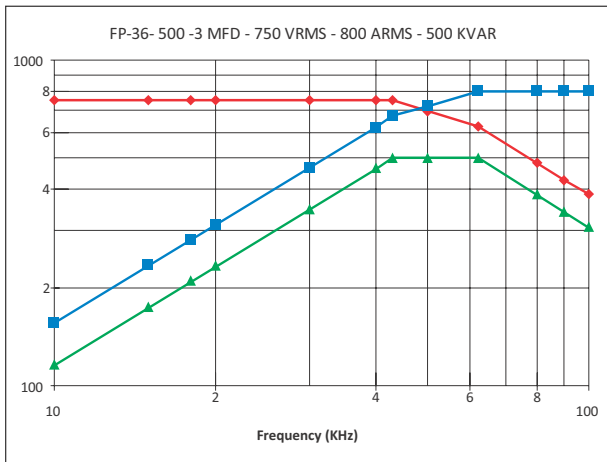
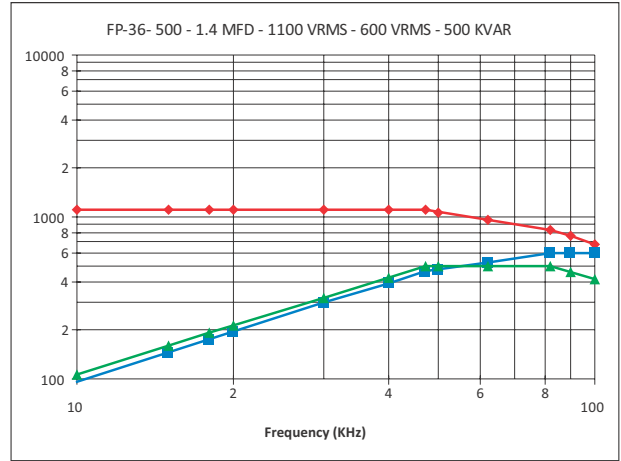
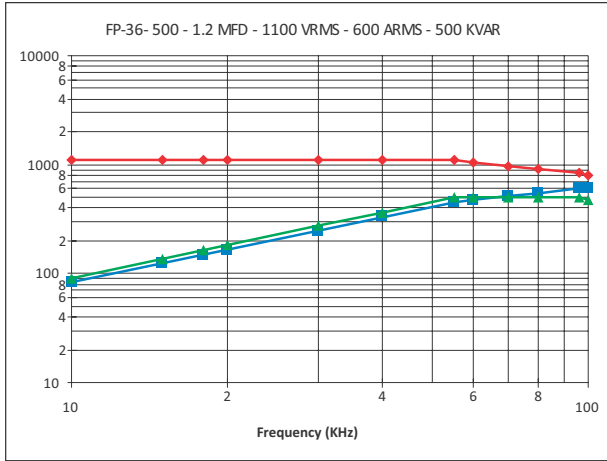

## FP-36-500

### Frequency Derating

—◆— Voltage    —■— Current    —▲— Power

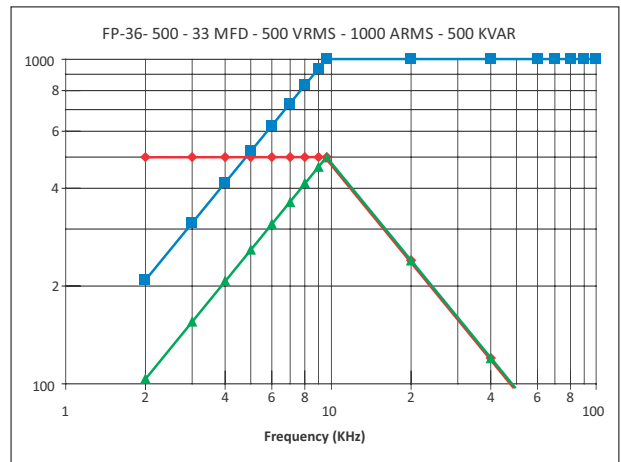
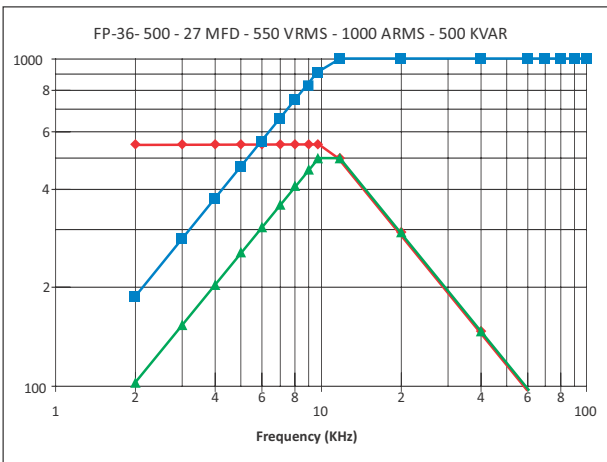
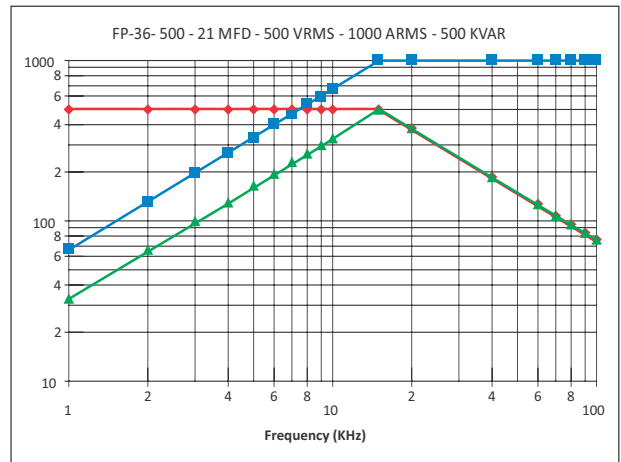
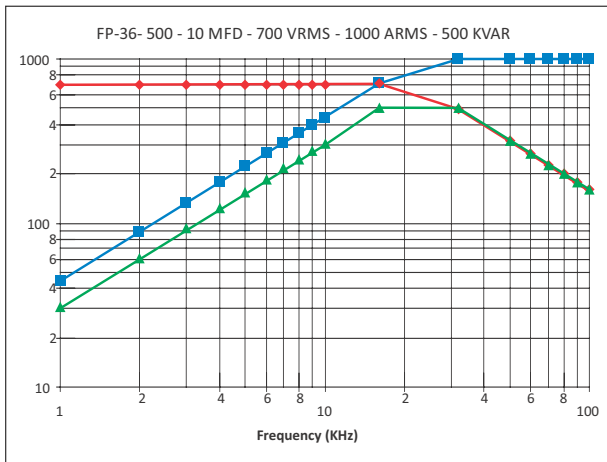
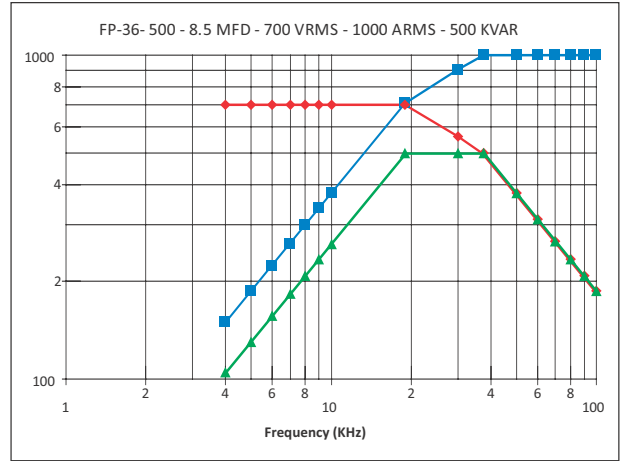
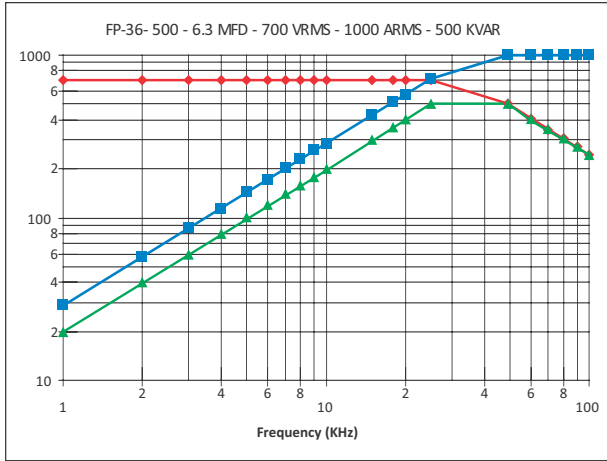

## FP-36-500

### Frequency Derating

