

FP-11-500

Highlights

- Conduction cooled
- 100% leak proof
- Polypropylene dielectric
- Self-healing
- Operating frequency 100KHz
- Maximum operating core temperature 85°C
- Capacitance tolerance $\pm 10\%$
- Flame retardant UL94 - V0, ROHS compliant



Standard Capacitor Values

| Rated Voltage Vrms | Nominal capacitance MFD at 1KHz | Max current Irms | Max power Kvars | Frequency KHz | ESR mΩ | Dimensions mm | | | Case Code | Terminal Style | Ordering Code |
|-----------------------|------------------------------------|---------------------|--------------------|------------------|-----------|------------------|------|----|--------------|-------------------|-------------------------|
| | | | | | | ØD | H | Ød | | | |
| 1100 | 1.2 | 600 | 500 | 55-96 | 1.5 | 80 | 71.5 | 60 | W1 | STD | SP001U21100A90W10STDK01 |
| | 1.4 | 600 | 500 | 46-83 | 1.2 | 80 | 71.5 | 60 | W1 | STD | SP001U41100A90W10STDK01 |
| 750 | 3.0 | 800 | 500 | 47-68 | 1.1 | 80 | 71.5 | 60 | W1 | STD | SP000030750A90W10STDK01 |
| | 3.3 | 800 | 500 | 43-62 | 1.0 | 80 | 71.5 | 60 | W1 | STD | SP003U30750A90W10STDK01 |
| 900 | 4.0 | 700 | 500 | 25-39 | 0.9 | 102 | 71.5 | 60 | W4 | STD | SP000040900A90W40STDK01 |
| 700 | 5.6 | 1000 | 500 | 29-57 | 0.9 | 80 | 71.5 | 60 | W1 | STD | SP005U60700A90W10STDK01 |
| | 6.3 | 1000 | 500 | 26-51 | 0.8 | 80 | 71.5 | 60 | W1 | STD | SP006U30700A90W10STDK01 |
| | 8.5 | 1000 | 500 | 19-38 | 0.7 | 88 | 71.5 | 60 | W2 | STD | SP008U50700A90W20STDK01 |
| | 10 | 1000 | 500 | 16-32 | 0.6 | 95 | 71.5 | 60 | W3 | STD | SP000100700A90W30STDK01 |
| 500 | 21 | 1000 | 500 | 15 | 0.4 | 80 | 71.5 | 60 | W1 | STD | SP000210500A90W10STDK01 |
| 550 | 27 | 1000 | 500 | 10-12 | 0.3 | 102 | 71.5 | 60 | W4 | STD | SP000270550A90W40STDK01 |
| 500 | 33 | 1000 | 500 | 10 | 0.3 | 102 | 71.5 | 60 | W4 | STD | SP000330500A90W40STDK01 |
| | 37 | 1000 | 500 | 9 | 0.2 | 102 | 71.5 | 60 | W4 | STD | SP000370500A90W40STDK01 |

Capacitor Drawing and Terminal Style

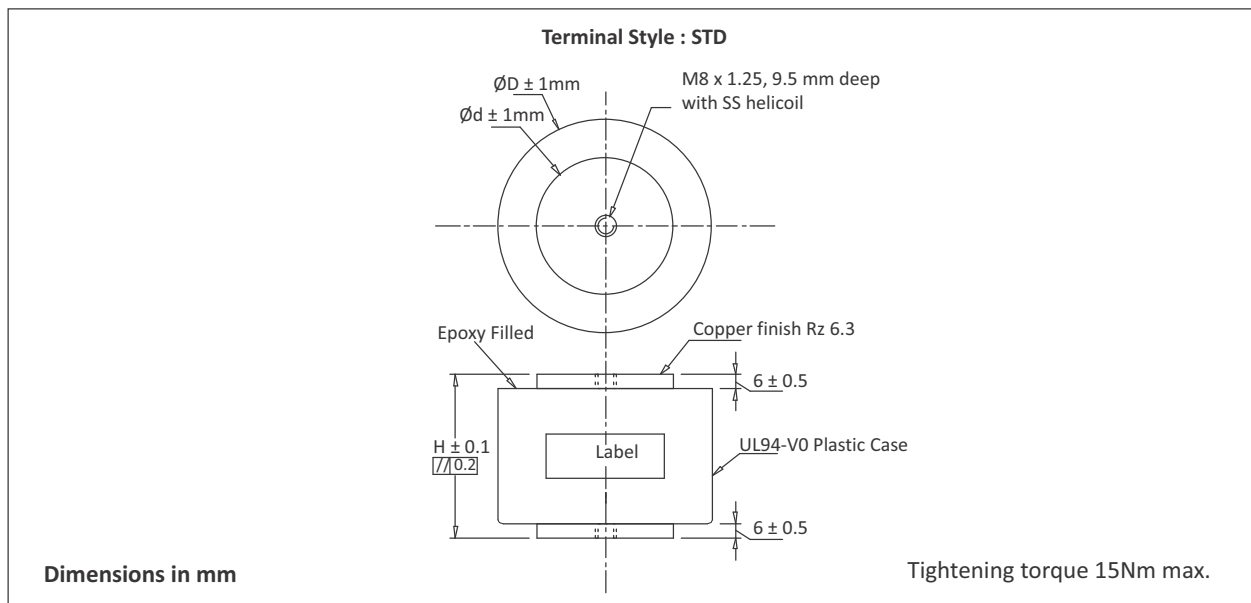

FP-11-500

Frequency Derating

—◆— Voltage —■— Current —▲— Power

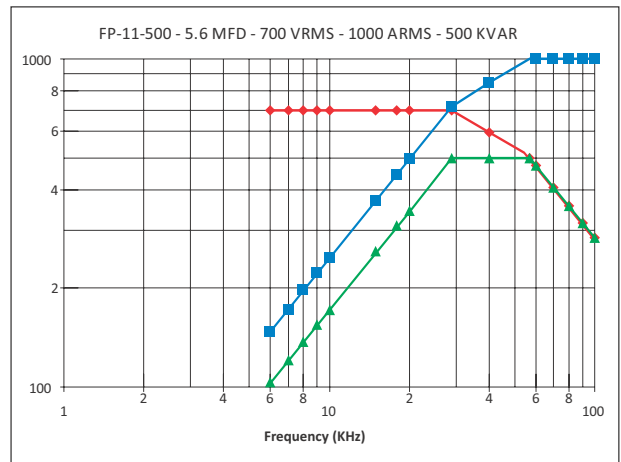
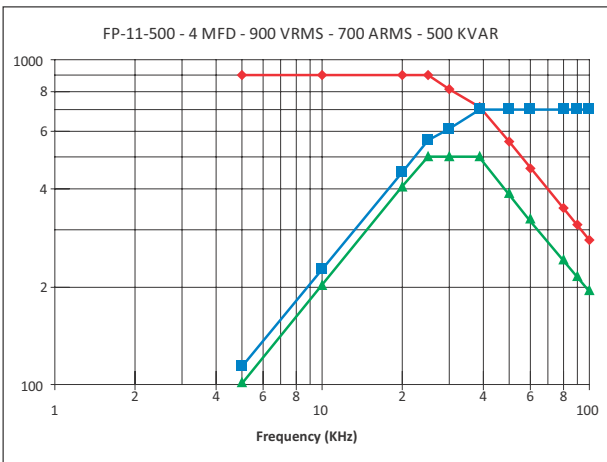
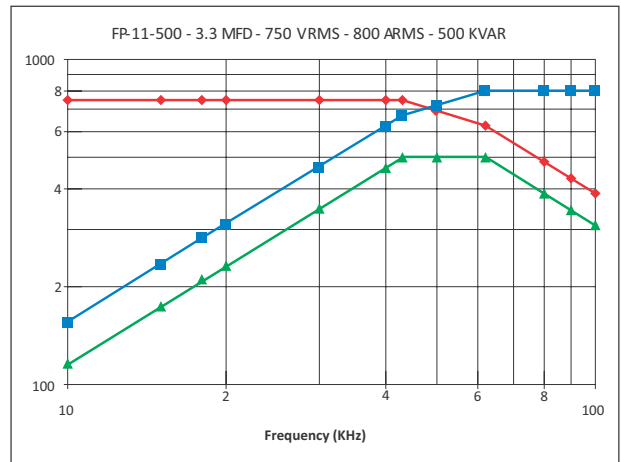
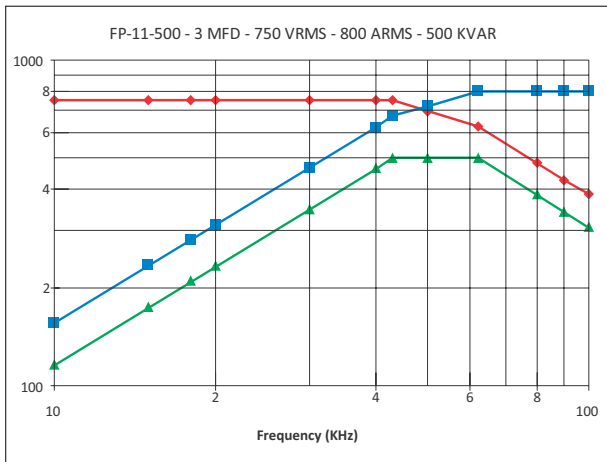
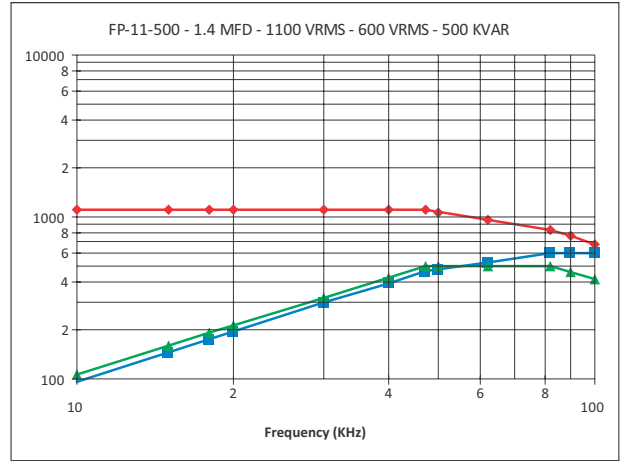
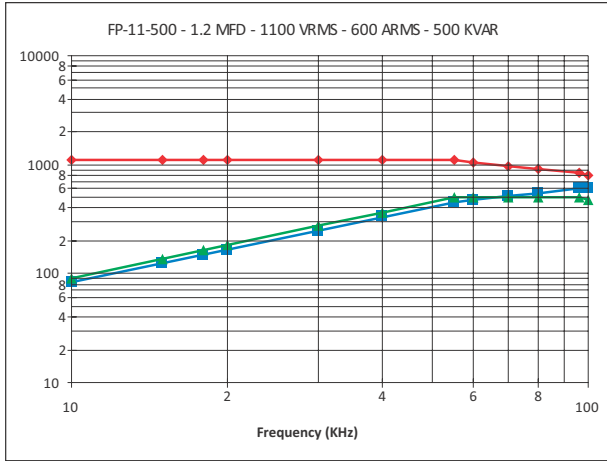

FP-11-500

Frequency Derating

—◆— Voltage —■— Current —▲— Power

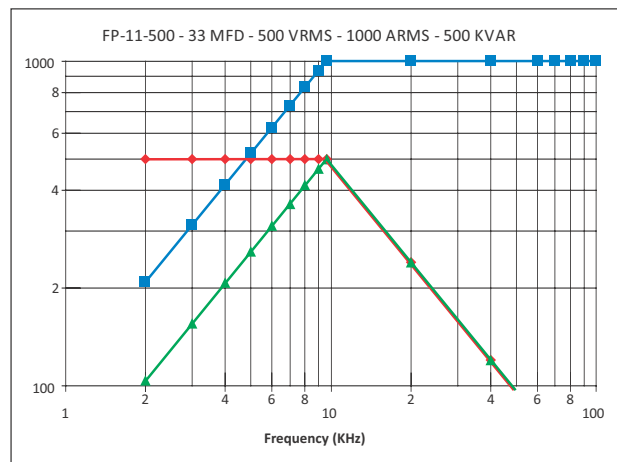
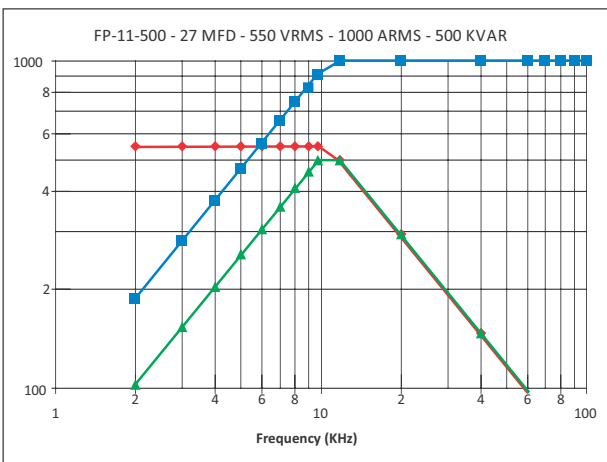
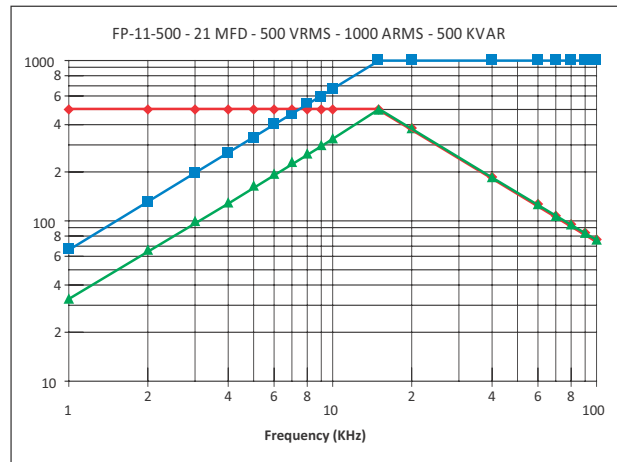
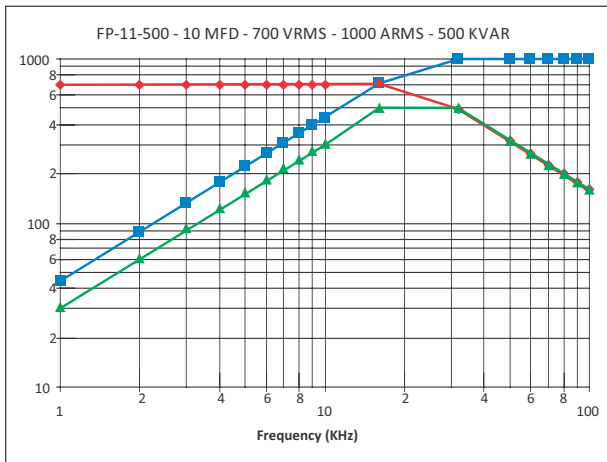
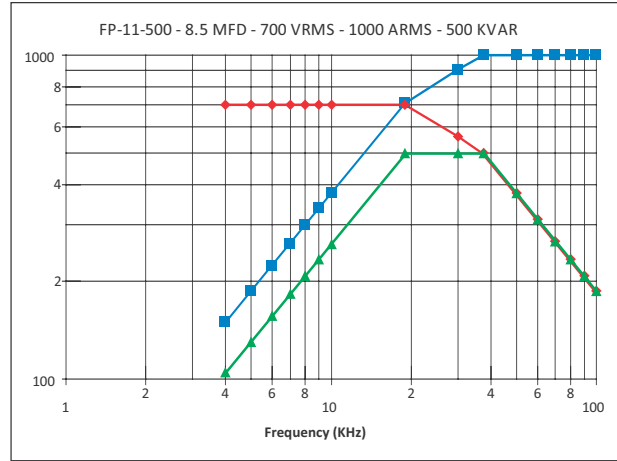
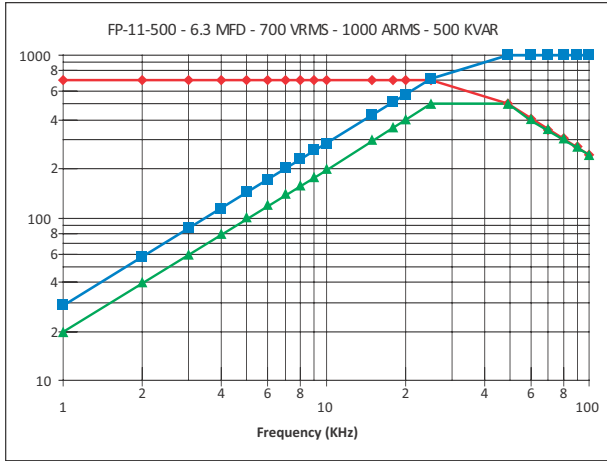

FP-11-500

Frequency Derating

