

## FP-60-700

### Highlights

- Conduction cooled
- Polypropylene dielectric
- Self-healing
- Operating frequency 30KHz
- Maximum operating core temperature 85°C
- Capacitance tolerance  $\pm 10\%$
- Flame retardant UL94 - V0, ROHS compliant

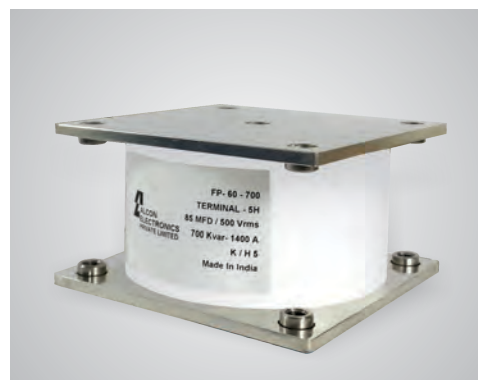

### Standard Capacitor Values

Rated Voltage Vrms	Nominal capacitance MFD at 1KHz	Max current Irms	Max power Kvars	Frequency KHz	ESR mΩ	Dimensions mm			Case Code	Terminal Style	Ordering Code
						B	H	L			
1000	5.0	800	700	22-29	0.7	72	130	130	0W8	5H	SP010000005BM0W8005HK01
900	9.0	900	700	15.3-20	0.6	72	130	130	0W8	5H	SP009000009BM0W8005HK01
850	12.0	1000	700	19-19	0.55	72	130	130	0W8	5H	SP008500012BM0W8005HK01
	14.0	1000	700	11-16.2	0.5	72	130	130	0W8	5H	SP008500014BM0W8005HK01
800	19.0	1000	700	9.2-12	0.4	72	130	130	0W8	5H	SP008000019BM0W8005HK01
700	25.0	1050	700	9-11	0.35	72	130	130	0W8	5H	SP007000025BM0W8005HK01
	27.0	1100	700	8.4-10.2	0.3	72	130	130	0W8	5H	SP007000027BM0W8005HK01
600	33.0	1150	700	6.9-9.1	0.2	72	130	130	0W8	5H	SP006000033BM0W8005HK01
	46.0	1200	700	6.7-7.1	0.15	72	130	130	0W8	5H	SP006000046BM0W8005HK01
	63.0	1200	700	4.5-5.7	0.1	72	130	130	0W8	5H	SP006000063BM0W8005HK01
500	80.0	1400	700	5.6-5.6	0.08	72	130	130	0W8	5H	SP005000080BM0W8005HK01
	85.0	1400	700	5.2-5.2	0.07	72	130	130	0W8	5H	SP005000085BM0W8005HK01

### Capacitor Drawing and Terminal Style

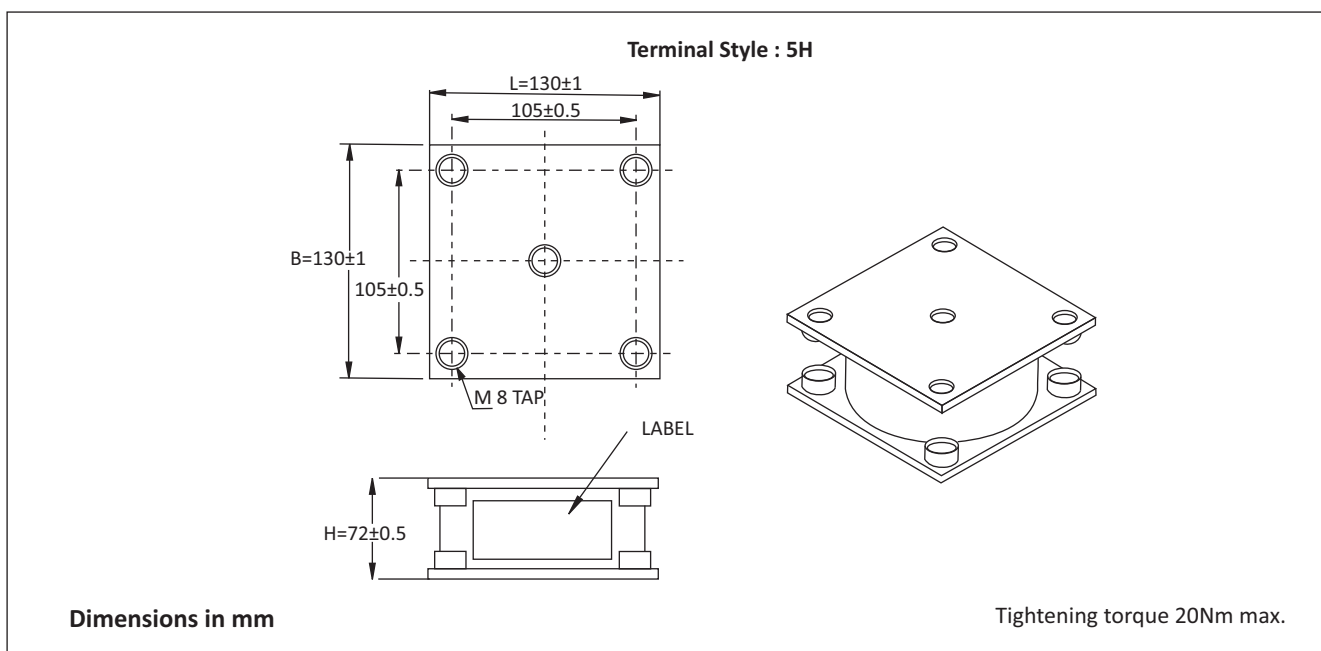

## FP-60-700

### Frequency Derating

—◆— Voltage    —■— Current    —▲— Power

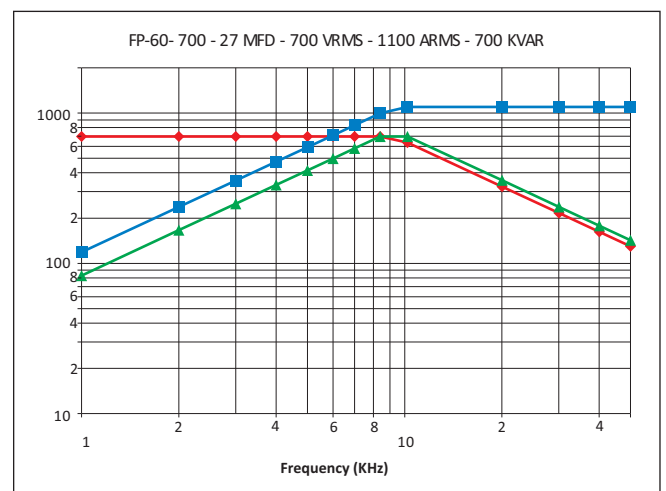
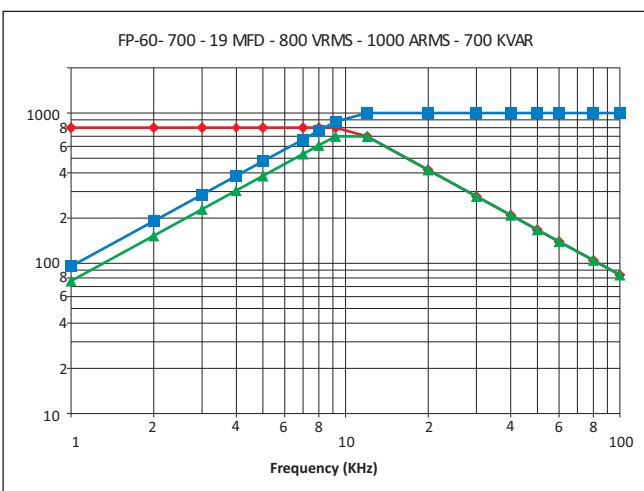
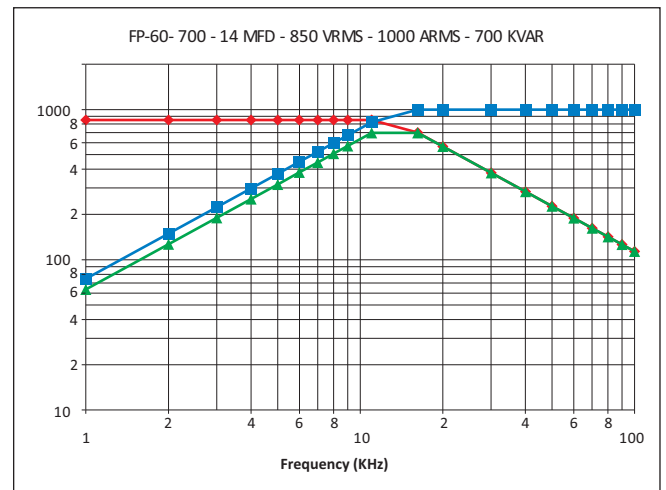
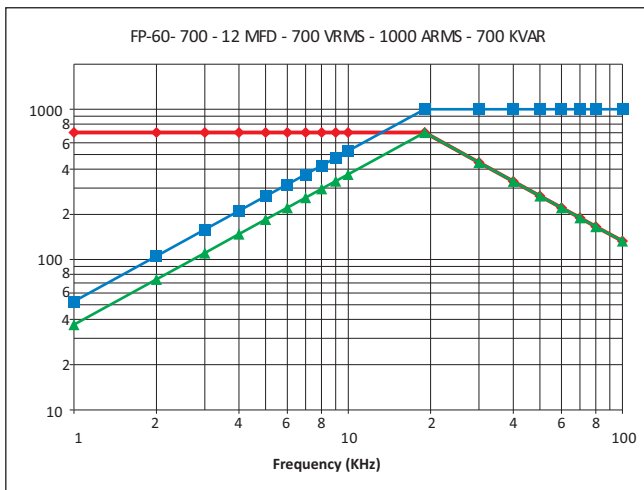
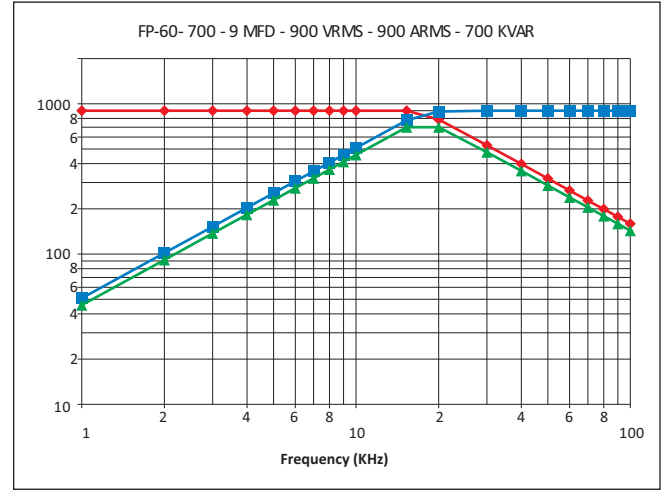
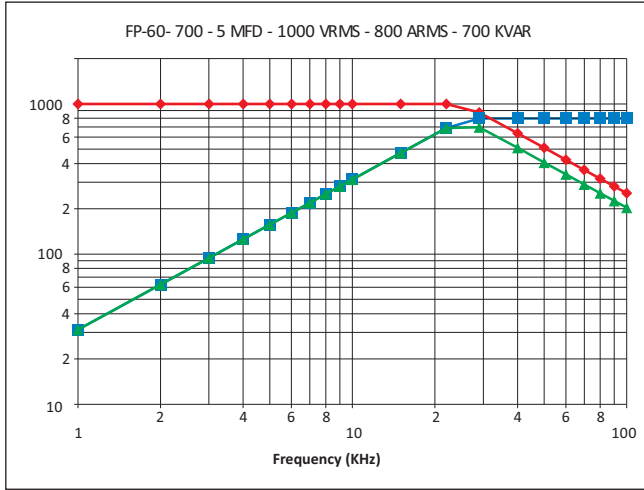

## FP-60-700

### Frequency Derating

—●— Voltage    —■— Current    —▲— Power

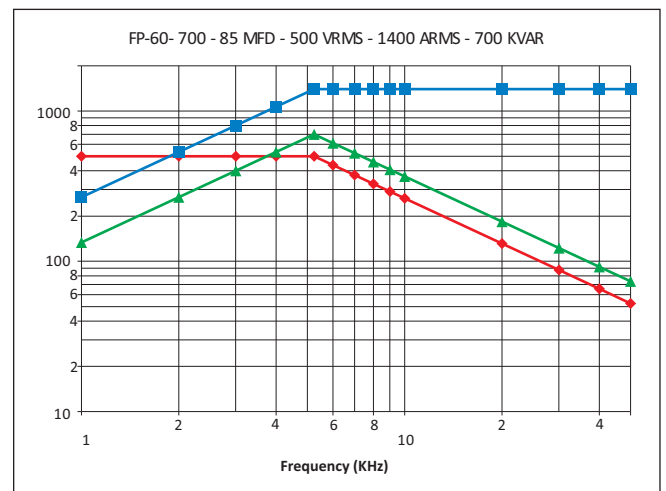
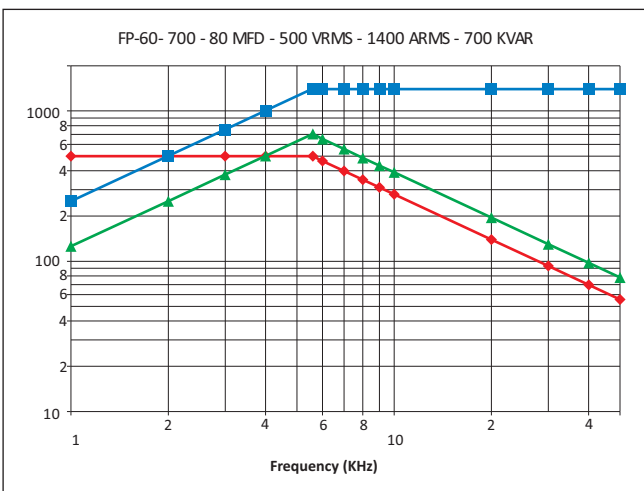
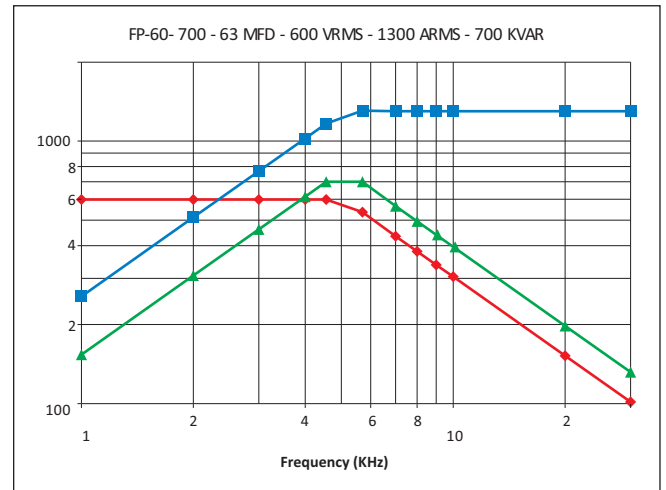
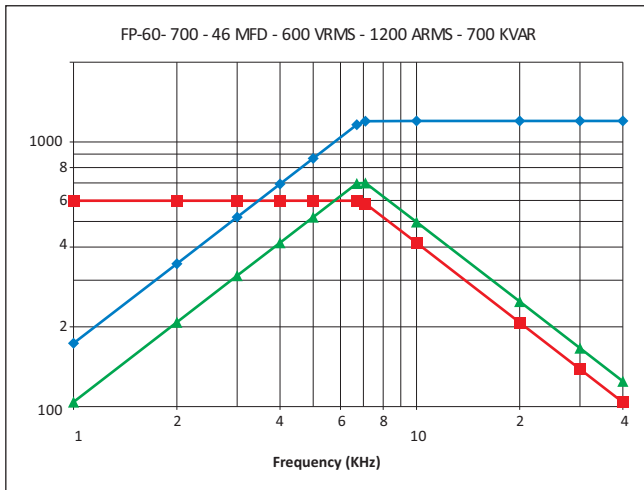
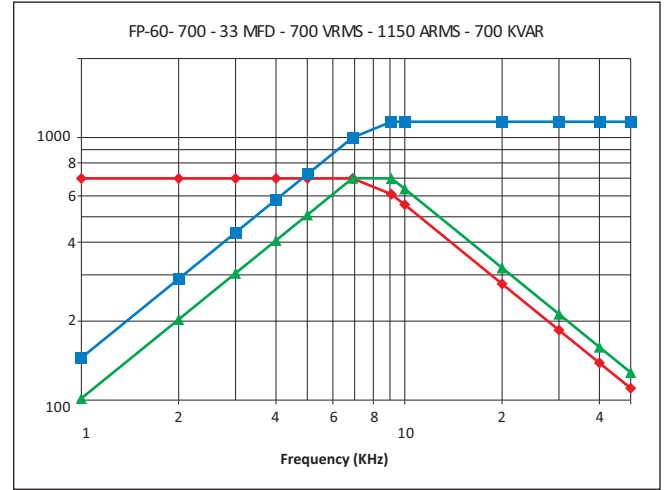
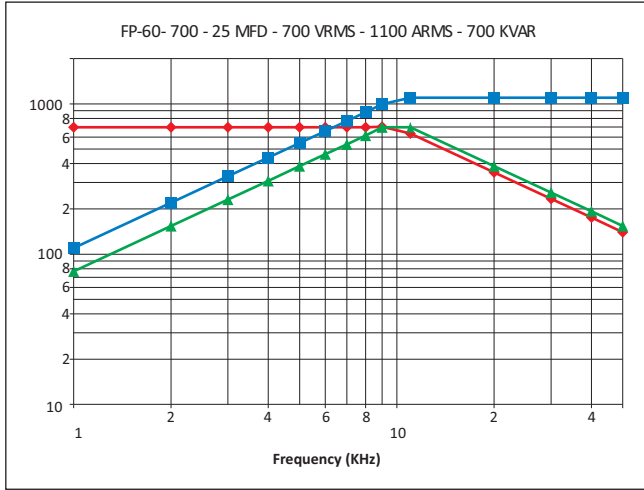

Catalogue No. AEPL FP-60-700-AUG-2017

The specification shown herein ( page 1 to 4 ) pertain to the current manufacturing range of the Company. The Company reserves the right to change and /or modify any part of or whole of the specifications as a result of research and development and as may be necessary, without prior notice

All Products not for marketing / sale in all countries.